

03/24-882

Canon

EOS-1 **V**

EOS-1 **V** HS



E

English Edition
INSTRUCTIONS



Thank you for purchasing a Canon product.

The EOS-1V is a high-performance autofocus single-lens reflex camera equipped with high-precision Area AF.

Photograph a wide variety of subjects under almost any condition. Let the camera do everything automatically or take full control. In any case, operation is simple with the electronic dials.

Before taking pictures, read this instruction booklet and familiarize yourself with your new camera.

■ Symbols

-  The Caution symbol alerts you to actions to prevent picture-taking problems.
-  The Note symbol gives additional information for basic camera operation.
-  The Light bulb symbol offers helpful tips for operating your camera or taking pictures.

Read "Handling Precautions" on page 6 to prevent camera malfunction and damage.

Keep this instruction booklet handy for easy reference.

■ Precautions

- Before using the camera for an important event, be sure to take test shots to make sure the camera operates properly.
- EOS cameras have a lens mount for dedicated operation (autofocusing, exposure control, etc.) with EF lenses. Using a non-EF lens with an EOS camera may result in improper camera or lens operation.

Note that the warranty does not cover any camera malfunction or damage occurring with the use of non-Canon accessories.

Contents

Handling Precautions	6
Nomenclature	8
Conventions Used in this Instruction Booklet	12

1 Before You Start **13**

Basic Operation	14
Installing the Battery and Checking the Battery Level	19
Mounting and Detaching a Lens	21
Dioptric Adjustment	22
Film ID Imprinting	22
Loading and Unloading Film	25

2 Quick Start With Program AE **29**

Holding the Camera	32
--------------------------	----

3 Using Autofocus (AF) **33**

AF Mode Selection	34
Area AF Ellipse and Focusing Points	37
Focusing Point Selection	38
Focusing Point Registration and Switching	42
Focusing Point Activation Area	44
Focusing an Off-Center Subject	45
When Autofocus Fails (Manual Focusing)	47

4 Metering Modes **49**

Selecting a Metering Mode	50
Metering Modes	51

5 Shooting Modes **55**

Tv Shutter Speed-Priority AE	56
Av Aperture-Priority AE	58
DEP Depth-of-field AE	61
M Manual Exposure	65
Setting Exposure Compensation	67
Autoexposure Bracketing	69
AE Lock	71

Setting the Film Speed Manually.....	73	
☑ Multiple Exposures.....	74	
Bulb Exposures.....	76	1
Single-Frame and Continuous Shooting.....	77	
Self-timer Operation.....	79	
Depth-of-field Preview.....	80	2
Mirror Lockup.....	81	
LCD Panel Illumination.....	82	
Using B/W Infrared Film.....	82	
6 Flash Photography.....	83	3
Flash Photography with Speedlite 550EX.....	84	
Using Other EOS-Dedicated Speedlites.....	93	
Using Non-Canon Flash Units.....	94	
7 Custom Functions.....	95	4
Selecting and Setting a Custom Functions.....	96	
Canceling a Custom Function.....	97	
Custom Function Settings.....	98	5
Personal Functions.....	111	
Custom Function Group.....	112	
Recording the Shooting Data.....	114	6
8 For EOS-1V HS Users.....	115	
9 Reference Section.....	119	7
Basic Photography Terms.....	120	
Troubleshooting Guide.....	122	
Exposure Warning List.....	124	8
Program Line.....	125	
Shutter Speed and Aperture Readouts.....	126	
Interchanging the Focusing Screen.....	127	
Major Accessories.....	129	9
Major Specifications.....	134	
Index.....	138	

Handling Precautions

Camera Care and Storage

- (1) The camera is a precision instrument. Do not drop it or subject it to physical shock.
- (2) This camera is not waterproof and cannot be used underwater. If the camera gets really wet, promptly consult your nearest Canon Service Center. Wipe off any water droplets with a dry cloth. If the camera has been exposed to salty air, wipe with a well-wrung damp cloth.
- (3) Do not leave the camera in places prone to excessive heat such as in a car on a sunny day. Excessive heat can cause the camera to malfunction.
- (4) The camera contains precision electronic circuitry. Never attempt to disassemble the camera.
- (5) Use only a blower brush to blow away dust on the lens, viewfinder eyepiece, focusing screen, film compartment, and mirror. Do not use an organic solvent-containing cleaner to clean the camera body or lens. For stubborn dirt, consult your nearest Canon Service Center.
- (6) The shutter curtains are extremely thin. Use only a blower to clean. Be careful not to blow air too forcefully on the shutter curtains. The shutter curtains can be easily deformed or damaged. Also, when loading and unloading film, be careful not to touch the shutter curtains.
- (7) Do not touch the electrical contacts with your fingers. Otherwise corrosion may develop on the contacts, resulting in improper camera operation.
- (8) If the camera is not to be used for an extended period, remove the battery. Store the camera in a well-ventilated, cool, dry place. During the storage period, release the shutter a few times once in a while.
- (9) Avoid storing the camera in a laboratory, cabinet, etc., where corrosive chemicals are present.
- (10) If the camera has not been used for an extended period or if the camera is to be used for an important event, check the operation of all the camera controls or take it to your nearest Canon Service Center.
- (11) After detaching the lens from the camera, put on the lens caps or put down the lens with the rear end up to avoid scratching the lens surface and electrical contacts.
- (12) Even when the Main Switch is set to <OFF>, a small amount of power is still supplied to the camera's LCD panel. However, this does not affect the number of film rolls which can be taken with the battery.

LCD Displays



In time, the camera's LCD panel display and the LCD display in the viewfinder may fade and become difficult to read. If this happens, have it replaced (at cost) by a Canon Service Center.

At low temperatures, the LCD display response may become slower. And at 60°C or higher temperatures, the display may blacken. In either case, the display will return to normal at room temperature.

Lithium Batteries

- (1) The camera operates on one 2CR5 lithium battery. Check the battery level in the following cases (→page 20):
 - After replacing the batteries.
 - After not using the camera for an extended period.
 - The shutter stops working.
 - The camera is being used in a low-temperature environment.
 - You will be shooting an important event.
- (2) Before installing the batteries, wipe the battery contacts to remove any fingerprints and smudges. This is to prevent faulty connections and corrosion.
- (3) Never disassemble or recharge the battery. Also, never store a battery in high-temperature places or short circuit the battery contacts or toss a battery into a fire.
- (4) Although the battery works well even at low temperatures, battery performance may decline slightly at freezing temperatures. In such a case, keep a spare battery warm in a pocket, etc., and use and warm the batteries alternately.

How Low Battery Levels Affect Camera Operation

Even when  blinks or not on the LCD panel, a proper exposure will be obtained as long as the shutter releases. However, when the battery becomes exhausted, film advance and auto rewind may not work and  may blink on the LCD panel. After the battery is replaced with a new one, the film advance will resume. Also, pressing the rewind button will resume the film rewind operation.

Lens Electrical Contacts

After detaching the lens from the camera, put on the lens caps or put down the lens with the rear end up to avoid scratching the lens surface and electrical contacts.

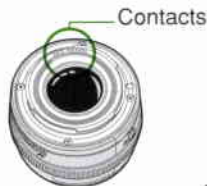

Nomenclature

- Reference page numbers are indicated in parentheses.
- In the text, camera controls are indicated by their respective icons.

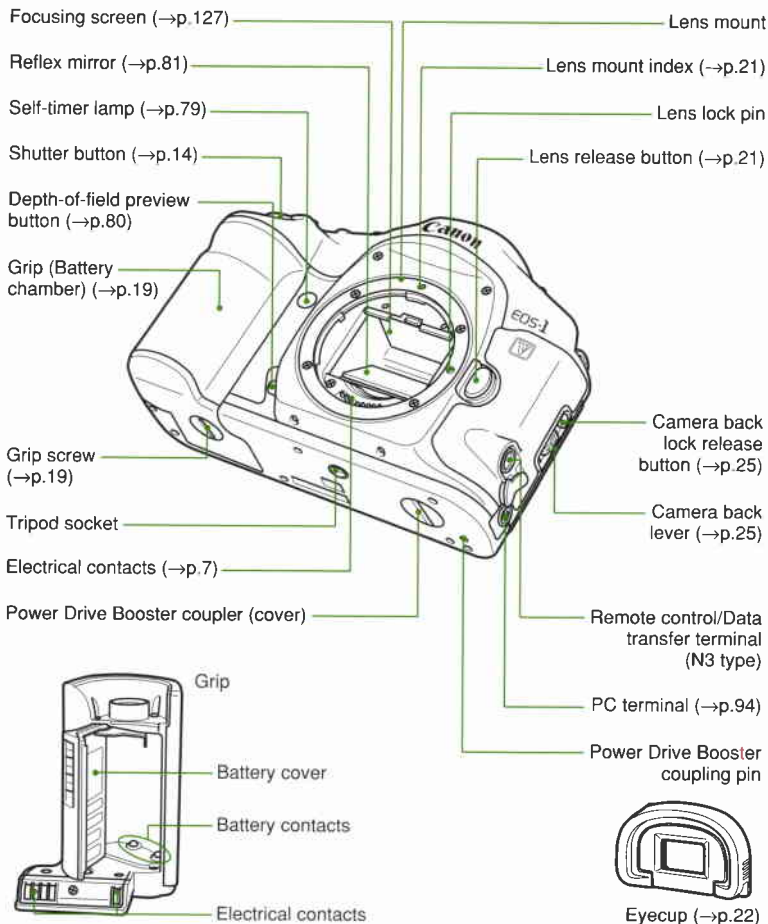

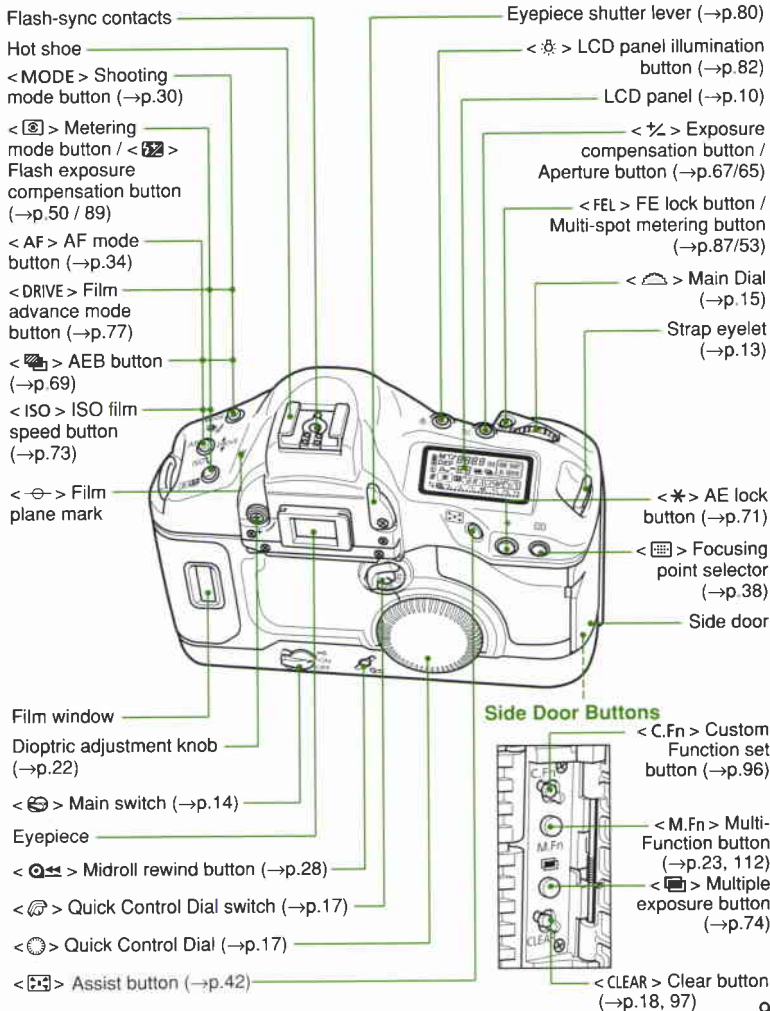

LCD Panel

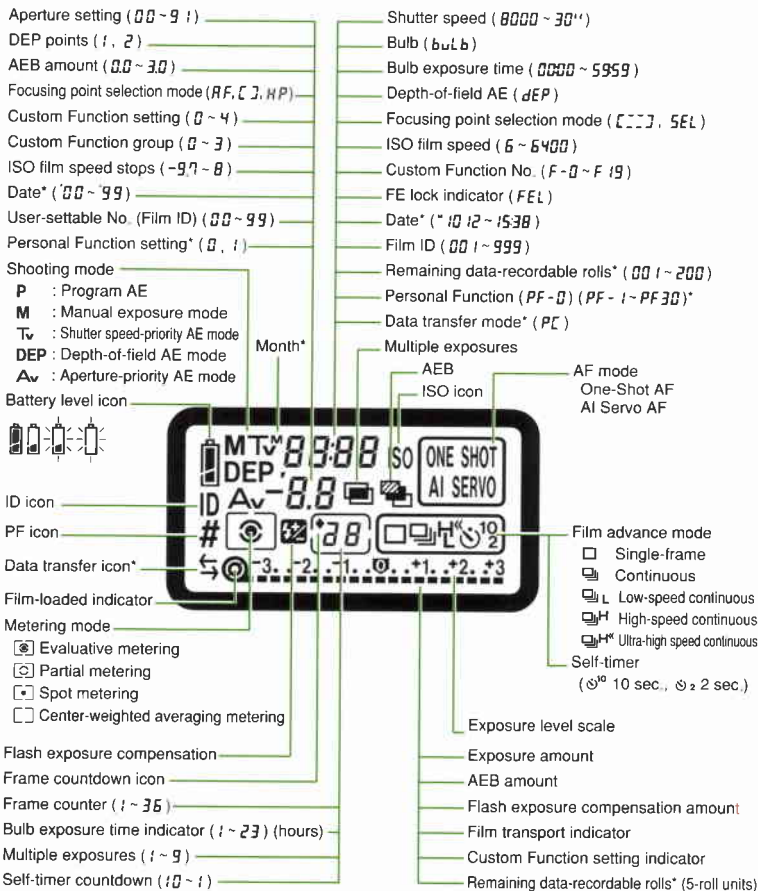

• The LCD panel has color-coded display boxes which contain icons or indications of related camera settings.



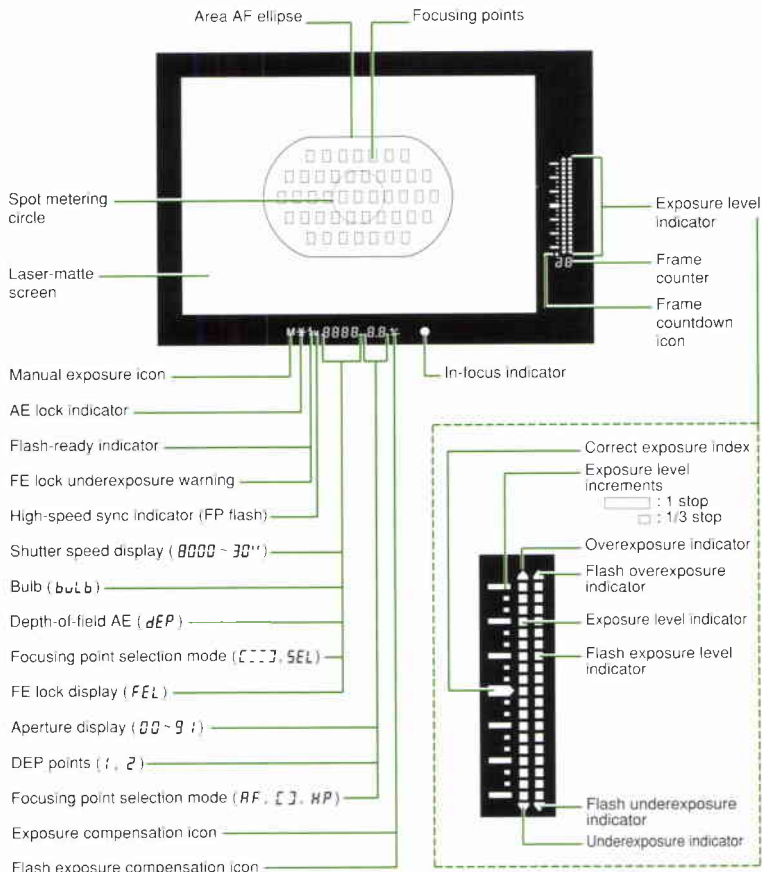

• Asterisked items are related to the EOS LINK SOFTWARE ES-E1 (sold separately).

Viewfinder Information





On pages 10 and 11, the LCD panel and viewfinder are shown with all the icons and indications displayed. The items actually displayed differ depending on the camera settings.



Conventions Used in this Instruction Booklet

- In this booklet, the <  > icon indicates the Main Dial, <  > is the Quick Control Dial, <  > is the main switch, and <  > is the Quick Control Dial switch.





- All the operations described in this booklet assume that the <  > switch is already set to < ON >. Before proceeding with any operation, first turn the <  > switch to < ON > or <  >.



- For <  > dial operations, make sure the <  > switch is set to < ON >.



- This symbol is used to indicate that there is a related Custom Function. For details, see "Custom Functions" on page 95.

- The camera control icons and markings used in this booklet correspond to the actual icons and markings found on the camera. See "Nomenclature" on page 8. Reference page numbers are also stated in parentheses (→p.■).
- In this instruction booklet, a Canon EF 50mm f/1.4 USM lens is used for explaining the procedures.
- The procedures are based on the assumption that the Custom Functions are set to the default settings.
- () indicates that the function described remains in effect for 6 sec. after the shutter button is released.
- () indicates that the function described remains in effect for 16 sec. after the shutter button is released.

This chapter explains a few preliminary steps and basic operations of the EOS-1V which you should know before you start taking pictures. If you will be using the camera for the first time, read this chapter first.

If you are familiar with the basic operations of EOS cameras and want to start using the camera right away, see "Quick Start with Program AE" on page 29.

Before You Start

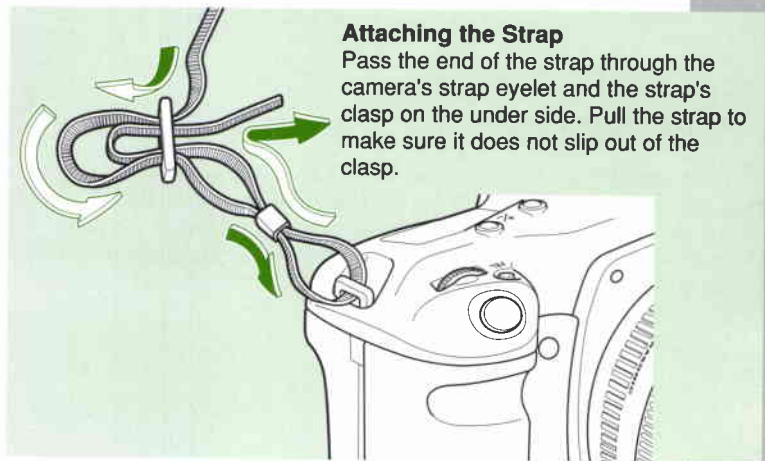

Attaching the Strap

Pass the end of the strap through the camera's strap eyelet and the strap's clasp on the under side. Pull the strap to make sure it does not slip out of the clasp.

Basic Operation

Main Switch

The camera operates only after the  switch is turned on. This switch has three settings:



<OFF> : The camera does not operate. Set to this position when not using the camera.



<ON> : To turn on the camera, set to this position.



<Beeper ON> : This is the same as <ON> except that it also enables the beeper to sound in the following cases:

- Focus is achieved in One-Shot AF mode.
- Focus is achieved with manual focus.

Shutter Button

You can press the shutter button halfway or all the way. Hold the camera steadily and press the shutter button slowly without any jerking movement. The difference between halfway and complete pressing of the shutter button is explained below. Beginners should practice pressing the shutter button halfway and completely before loading any film.



Halfway pressing

When the shutter button is pressed halfway, autofocus (AF) is activated to focus the subject. Autoexposure (AE) metering is also turned on to set the correct shutter speed and aperture which are displayed in the viewfinder and on the LCD panel for (⊙6).



Complete pressing

This releases the shutter and takes the picture. After the frame is exposed, the camera advances the film automatically.

Using the Electronic Dials

There are three ways to use the <⊙> dial:

1. Press and hold down a button and then turn the <⊙> dial while looking at the LCD panel. When the button is released, you can take a picture.

① Hold down a button...

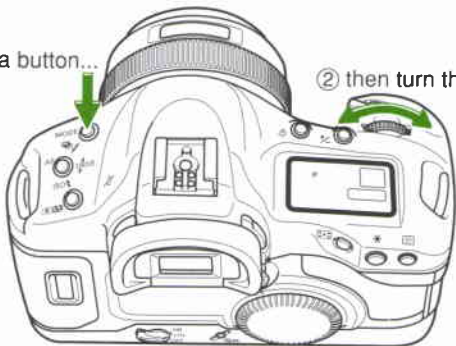



② then turn the <⊙>.

2. After pressing a button, turn the < > dial.

When a button is pressed, its function remains active for 6 or 16 seconds. You then look at the LCD panel and turn the <  > dial during this time. After the function turns off or when you press the shutter button halfway again, the camera will be ready to take a picture.

Buttons which turn on for 6 or 16 seconds are indicated in this instruction booklet with the following icons:

- () : The button's function remains active for 6 seconds after the button is released.
- () : The button's function remains active for 16 seconds after the button is released.

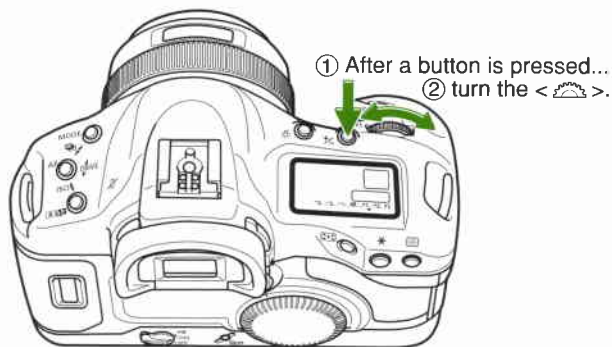

3. Just turn the < > dial.

While looking at the LCD panel, you can set the shutter speed, aperture, or another setting.

There are three ways to use the <⊙>:

1. While holding down a button, turn the <⊙> dial.
2. After pressing and releasing a button, turn the <⊙> dial.
3. Just turn the <⊙> dial.

Look at the LCD panel to confirm the setting.

To restore the button's function or to ready the camera for picture taking, turn the <☀> dial.

The <⊙> is used to set the following:

1. Real-time exposure compensation
2. Aperture
3. Flash exposure compensation
4. Focusing point selection

The <⊙> dial functions only when the <☞> switch is set to <ON>.



<OFF> : Set to this position to disable the <⊙>.



<ON> : Set to this position to enable the <⊙>.

Reverting to the Default Settings

With the EOS-1V, you can set the shooting mode, metering mode, and other settings as you wish. You can also use Custom Functions (→p.95) to customize camera controls and functions according to your preferences. These preferences can be reset to the default settings with the following procedure.

Resetting the camera to the default settings

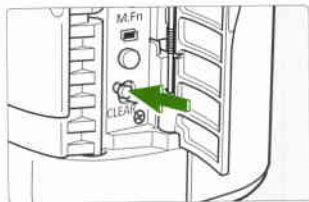

Open the side door and press the **< CLEAR > button.**

▸ This will reset the camera to the default settings shown in the table below.

Shooting mode	< P > Program AE
AF mode	One-Shot AF
Metering mode	Evaluative
Film advance mode	Single
Focusing point selection	Automatic
Multiple exposures	Canceled
Exposure compensation	0
Flash exposure compensation	0
AE lock	Canceled
FE lock	Canceled
AEB	Canceled
Custom Functions	Settings retained
Focusing point registration	Center focusing point

 When the camera is reset, the shooting mode will be set automatically to **< P > Program AE** (→p.29).

Resetting all Custom Functions except C.Fn-0 (→p.98) to the default settings

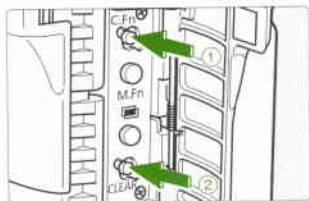

Open the side door, press the **< C.Fn > button**, then press the **< CLEAR > button.**

 "C.Fn" is the abbreviation for "Custom Function."

Installing the Battery and Checking the Battery Level

Installing the Battery

The battery is housed in the camera grip. **Remove the grip to install one 2CR5 lithium battery.**

- For the EOS-1V HS, see page 115.

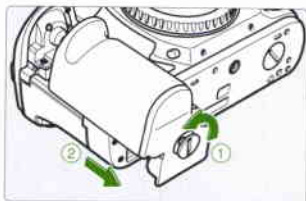

1 Remove the grip.

- Use a coin to turn and loosen the grip screw as shown by the arrow in the figure. Slide off the grip downward.

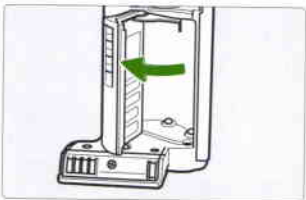

2 Open the cover.

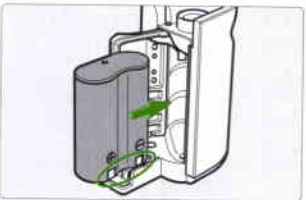

3 Install the battery.

- Install the battery so that the battery contacts are on the right and bottom. Then close the cover.

4 Reattach the grip.

- Reattach the grip to the camera, then turn the grip screw to tighten securely.

 Lithium batteries may not be available in certain areas. Carry a spare battery when going on a trip or when you will use many rolls of film.

Checking the Battery Level

Check the battery level after replacing the batteries or before using the camera.



Turn the **<S>** to **<ON>**.

• The battery level will be checked automatically and the LCD panel will then display one of the following battery level icons:

 : Battery level OK.

 : Keep spare battery handy.

 : Battery will soon be exhausted.

 : Replace with new battery.
(→p.7)

Battery Life (No. of Rolls)

Temperature	Rolls
At 20°C	75 (50)
At -20°C	18 (12)

- The table shows the number of 24-exposure rolls based on Canon's tests with a new battery and an EF 50mm f/1.4 USM lens. Figures in parentheses are the number of 36-exposure rolls.
- Information on battery life with Power Drive Booster PB-E2 or E1 and Battery Pack BP-E1 is provided in the respective instruction booklet.

- If the **<S>** is set to **<ON>** and nothing is displayed on the LCD panel, the battery may have been installed incorrectly. Take out the battery and install correctly. Then check the battery level again.
- Since actual shooting conditions may differ, the actual number of rolls may be less than the figures in the table.
- Pressing the shutter button halfway for prolonged periods or frequent autofocusing without taking any pictures will lower the number of rolls that can be taken.

- When the camera is not to be used, set the **<S>** to **<OFF>**. This will prevent accidental battery drainage if the shutter button is held down inadvertently.
- The battery level is indicated each time the **<S>** is turned on. To check the current battery level, turn on the **<S>** again.

Mounting and Detaching a Lens

Mounting a Lens

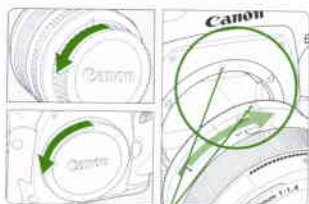

Red dots

1

Remove the caps.

- Remove the rear lens cap and the body cap by turning them as shown by the arrow.

2

Attach the lens.

- Align the red dots on the lens and camera and turn the lens as shown by the arrow until it snaps in place.

3

On the lens, set the focus mode switch to AF.

- If the focus mode switch is set to **MF** (or **M** on older lenses), autofocus will not operate.

4

Remove the front lens cap.

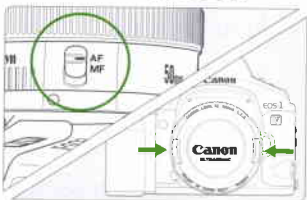

Detaching the Lens

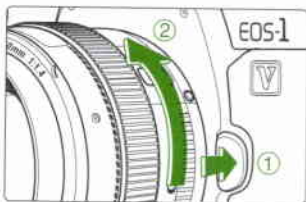

While pressing the lens release button, turn the lens as shown by the arrow.

- Turn the lens until it stops, then remove the lens.



- Be careful not to lose the lens caps and body cap.
- **AF** stands for autofocus.
- **MF** or **M** stands for manual focus.

Dioptric Adjustment

By adjusting the diopter to suit your vision (with or without eyeglasses), the viewfinder image will look clearer. The camera's adjustable dioptic range is -3 to $+1$ dpt.

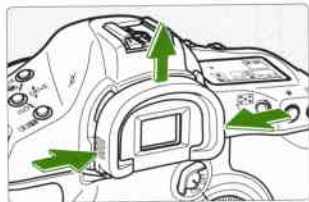

1

Remove the eyecup.

- While grasping both sides of the eyecup, slide it upward to remove.

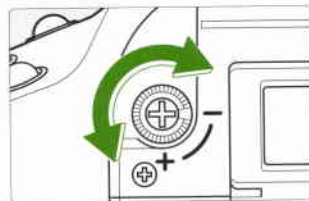

2

Turn the dioptic adjustment knob.

- Turn the knob to the right or left until the focusing point or the center spot metering circle looks sharp in the viewfinder.
- The diagram shows the knob set at the standard diopter (-1 dpt).

3

Reattach the eyecup.

 If the viewfinder still does not look sharp after you turn the dioptic adjustment knob, use one of the E-series dioptic adjustment lenses (sold separately). (→p.132)

Film ID Imprinting

A film ID No. consisting of a user-settable number (two digits) and a film roll No. (three digits) is imprinted automatically on the film leader. The user-settable number can be used to identify which EOS-1V body you used (if you have multiple EOS-1V bodies) to shoot that roll. The film roll No. counts up each time you load a roll of film into the camera. This way, you can check the order in which the rolls were exposed. The film ID is also used to match the shooting data recorded by the camera. The shooting data is transferred to a personal computer with the EOS LINK SOFTWARE ES-E1 (sold separately).

- ❗ Be sure to set the user-settable No. before loading the film. The film ID is imprinted automatically as it advances to frame 1 after loading. You cannot set the user-settable No. once the film has been loaded. You also cannot set the film roll No.

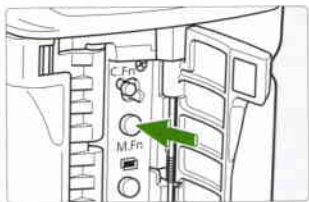
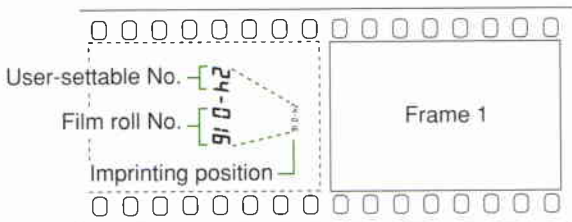

M.Fn: Multi Function. This refers to the EOS-1V's extended functions.

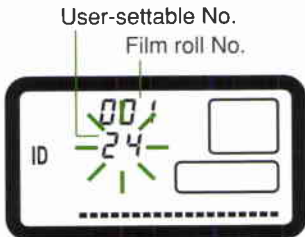

1 Press the <M.Fn> button to set the film ID setting mode.

- Each time you press the button, the following icons will be displayed in turn on the left side of the LCD panel. Display the ID icon.

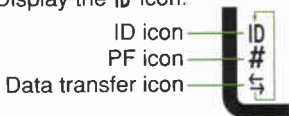

- The blinking number is the user-settable No.
- After the film advances to frame 1, the user-settable No. will be displayed and it cannot be changed.

2 Turn the <DIAL> dial to set the desired user-settable No.

- You can set any number from 00 to 99.
- The film roll No. is set sequentially from 001 to 999. After 999, it will start from 001 again.



3 Press the shutter button halfway.

- The LCD panel will return to the normal display and the user-settable No. will be set.

When the film is loaded, the ID icon will be displayed on the LCD panel while the film ID is being imprinted. (→p.26)

- In low temperatures (-10°C), the liquid crystal used for imprinting the film ID will have a slower response. Therefore, it may take a few seconds for the imprinting to be completed. To ensure proper film ID imprinting, do not start taking pictures until the ID icon on the LCD panel turns off. If you take a picture during film ID imprinting, the imprinting will be canceled and the picture will be taken.
- Film ID imprinting is assured between 45°C and -10°C . In colder temperatures, the response of the liquid crystal will be extremely slow and the film ID might fail to be imprinted.
- If a roll of film is rewound in midroll and later loaded into the camera again, the film ID will be imprinted over the previous film ID.
- Depending on your photofinisher, the film leader where the film ID is imprinted might not come back with your processed film. When submitting the film for processing, be sure to mention that you want the film leader returned as well.

- The film ID imprinting cannot be turned off.
- When you press the $\langle \text{ID} \rangle$ button in step 2 on the preceding page, the number of remaining rolls whose shooting data can be stored in the camera's memory will be displayed. This number is used when you use the EOS LINK SOFTWARE ES-E1 (sold separately).

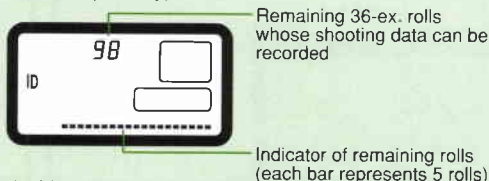

- If Dateback DB-E2 (sold separately) is used instead of the standard camera back, there will be no film ID imprinting.

Loading and Unloading Film

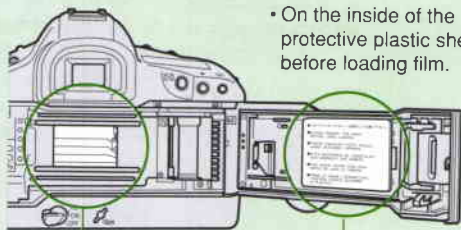

Shutter curtain

Plastic protector

- On the inside of the camera back, there is a protective plastic sheet. Be sure to remove it before loading film.

- The shutter curtains have been manufactured at very high precision. Never touch them with your fingers. When loading film, do not touch or damage the curtains with your fingers or film.

Loading Film

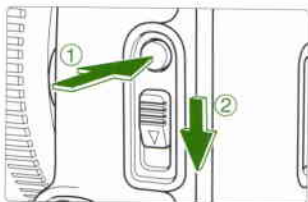

1 Open the camera back.

- Use your thumb to press the camera back lock release button and slide the camera back lever down as shown by the arrow to open the camera back.
- If this is difficult to do with one finger, use one finger to press the lock release button and another finger to slide down the lever.

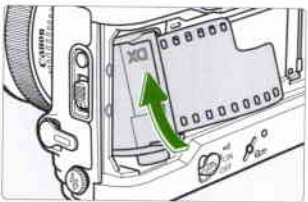

2 Insert the film cartridge at an angle as shown in the figure.

- Set the  to <ON>.

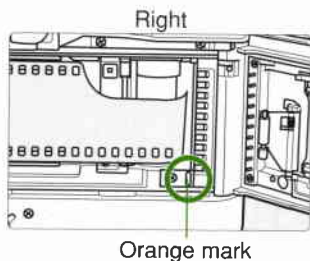

3 Pull the edge of the film leader to the orange mark on the camera.

- Hold down the film cartridge while pulling out the film leader.
- If the edge of the film leader goes beyond the orange mark, rewind some of the film back into the cartridge.

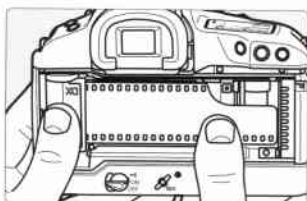
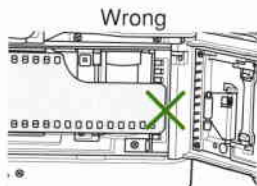

4 Close the camera back.

- After checking that the film leader edge is correctly aligned with the orange mark, close the camera back.
- The film will advance to frame 1 automatically.
- After the film ID is imprinted, the cartridge icon and frame counter "1" will be displayed.

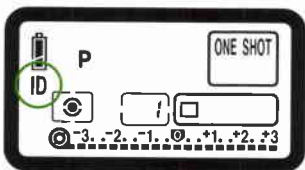

Film ID being imprinted

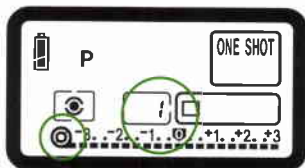



- If the film is not loaded properly, the film transport indicator <■■■■> will blink and the shutter will not work. Reload the film properly.
- Infrared film can also be used. (→p.82)



In hot and humid environments, do not remove the film packaging until you are ready to load the film.

C.Fn The frame counter can either count up or count down. (C.Fn-8-1→p.103)

Setting the Film Speed

The camera sets the film speed automatically within ISO 25 - 5000 with the film's DX code.



Press the <AF> and <ISO> buttons simultaneously.

- The LCD panel will display the ISO icon and the film speed.



If the film speed displayed does not match the film speed or if the film is not DX-coded, see "Setting the Film Speed Manually" on page 73.

C.Fn C.Fn 3 can prevent the ISO film speed from being set automatically with the DX code. (→p.99)

Unloading Film

After the film's last frame is exposed, the camera rewinds the film automatically.

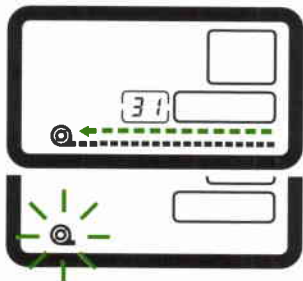

- ▶ When the film starts to rewind, the film advance and rewind indicator on the LCD panel will “flow” from right to left to indicate that the film is rewinding. The frame counter also counts in reverse.
- ▶ The film rewind ends automatically. Check that the < @ > icon on the LCD panel is blinking, then remove the film cartridge.

Midroll Rewind

To rewind the film in midroll, follow the procedure below.

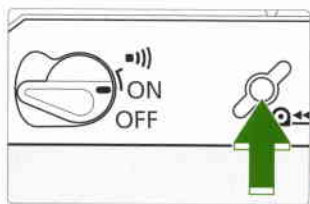

- 1 Press the < @ > button.**
 - ▶ The film will start rewinding. The subsequent operation will then be the same as normal film rewind.
- 2 Take out the film cartridge.**

 During film rewind, pressing the < @ > button also toggles between high-speed and low-speed (quiet) rewind.

C.Fn Custom Function C.Fn-1 can alter the rewind speed and method. (→p.98)

C.Fn Normally, the entire film leader is rewound inside the film cartridge. Custom Function C.Fn-2 can leave out the film leader after film rewind. (→p.99)

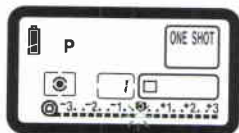

For quick and easy picture-taking, use the Program AE mode. This mode sets both the shutter speed and aperture automatically to suit the subject's brightness. Anyone can easily take pictures in this mode. By using the large Area AF ellipse in the viewfinder, it is easy to frame and capture a variety of subjects.

Quick Start With Program AE



First set the <  > switch to <ON>.



The Program AE mode is set automatically as the camera's initial shooting mode. (→p.17)



AE is an abbreviation for Auto Exposure.

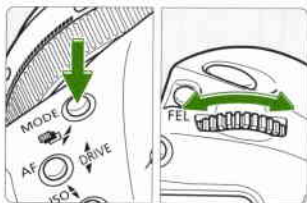

1 Select <P> on the LCD panel.

- While pressing the <MODE> button, turn the < < > dial to select <P>. Then release the <MODE> button.

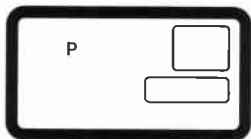

2 Focus the subject.



In-focus indicator
Area AF ellipse

- Look through the viewfinder and aim the Area AF ellipse over the subject. Then press the shutter button halfway.
- The focusing point which achieves focus flashes briefly. At the same time, the green in-focus indicator in the viewfinder is displayed.
- The exposure setting will be displayed on the LCD panel and in the viewfinder.
- If the in-focus indicator in the viewfinder blinks, the shutter will lock and a picture cannot be taken. See “When Autofocus Fails (Manual Focusing)” on page 47.

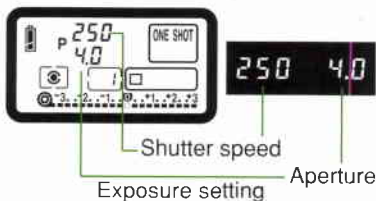

- 3** Make sure the exposure setting is not blinking, then press the shutter button completely to take the picture.

Exposure Warnings

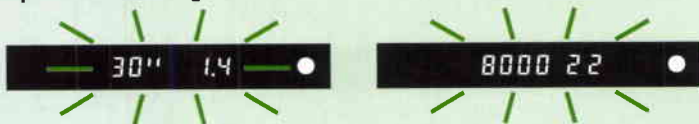

If the shutter speed or aperture blinks, it means a correct exposure cannot be obtained. Although the picture can be taken, it may come out too bright or too dark. For details, see "Exposure Warning List" on page 124.

- The focusing point which achieves focus flashes briefly. If the focusing point has been selected manually (→p.38), it will light dimly while it is active for ().
- If automatic focusing point selection (→p.38) has been set, all the focusing points that achieve focus will light.

Shifting the Program

In the Program AE <P> mode, you can freely change the shutter speed and aperture combination (program) set by the camera while retaining the same exposure value. This is called shifting the program.

To shift the program, press the shutter button halfway and turn the <  > dial until the desired shutter speed or aperture is displayed.

- The program shift setting is canceled after the picture is taken.

Holding the Camera

To obtain sharp pictures, hold the camera still to minimize camera shake.

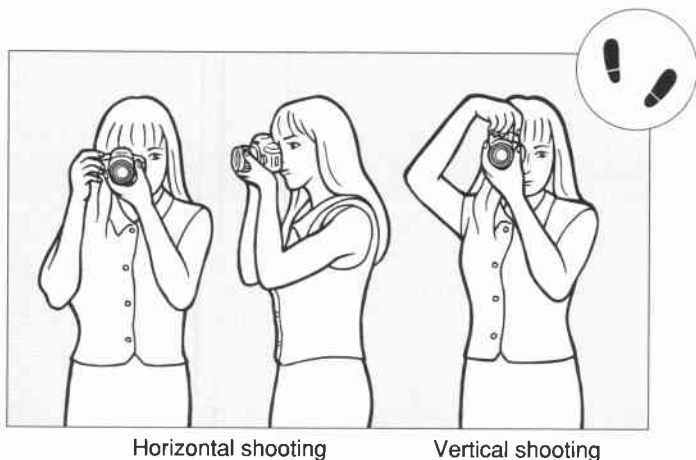

Horizontal shooting

Vertical shooting

- Firmly grasp the camera grip with your right hand, and press your right elbow lightly against your body.
- Hold the lens at the bottom with your left hand.
- Press the camera against your face and look through the viewfinder.
- To maintain a stable stance, place one foot in front of the other instead of lining up both feet.

 The camera can automatically sense whether it is in the horizontal or vertical position. The camera's internal detector will make a small sound when detecting the horizontal or vertical position.





The Area AF ellipse has 45 focusing points. By selecting the optimum focusing point, autofocus can be executed while you maintain the desired subject framing. You can also set the AF mode to suit the subject or intended effect.



Using Autofocus (AF)



First set the <  > switch and <  > switch to <ON>.

AF Mode Selection

AF stands for 'autofocus'. The camera has two AF modes: One-Shot AF for still subjects, and AI Servo AF for moving subjects. (AI is an abbreviation for Artificial Intelligence.) Select the AF mode that suits the subject.

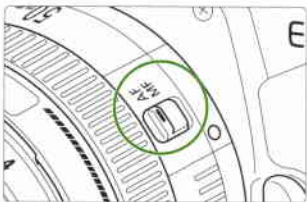

- 1** Set the lens focus mode switch to AF.

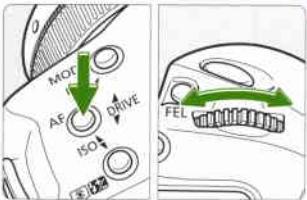

- 2** Set the AF mode.
- While pressing the camera's < AF > button, turn the <  > dial until the desired AF mode is displayed on the LCD panel. Then release the < AF > button.

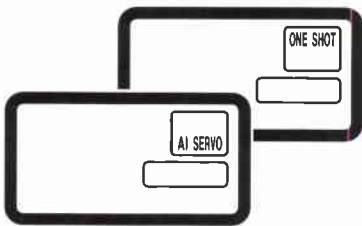

One-Shot AF for Still Subjects

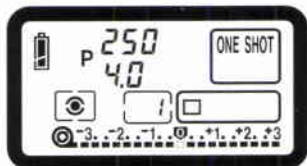
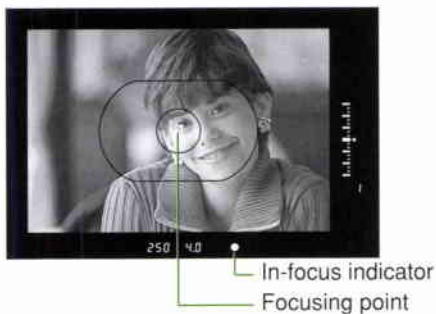

Pressing the shutter button halfway activates AF operation and achieves focus once.

- The focusing point which achieves focus flashes briefly and the in-focus indicator (●) in the viewfinder lights at the same time.
- With evaluative metering, the exposure setting (shutter speed and aperture) will be set when focus is achieved. The exposure setting and focus will be locked as long as the shutter button is pressed halfway. You can then recompose the shot while retaining the exposure setting and point of focus. (→p.45)



- When the $\langle \text{S} \rangle$ switch is set to $\langle \text{AF} \rangle$, the beeper will sound when focus is achieved.
- If focus cannot be achieved, the in-focus indicator (●) in the viewfinder will blink. If this occurs, a picture cannot be taken even if the shutter button is pressed completely. Reframe the shot and focus again. Also see "When Autofocus Fails (Manual Focusing)" on page 47.

AI Servo AF for Moving Subjects

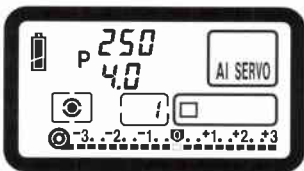

While you press the shutter button halfway, the camera focuses continuously.

- This AF mode suits moving subjects when the focusing distance keeps changing.
- With predictive AF*, the camera can also focus track a subject which steadily approaches or retreats from the camera.
- The exposure settings are set immediately before the picture is taken.

- When focus is achieved in the AI Servo AF mode, the viewfinder's in-focus indicator does not light and the beeper does not sound.
- If the viewfinder's in-focus indicator blinks, focus cannot be achieved.
- The focus cannot be locked (except when Custom Function C.Fn-4 is set to 2.)

* About Predictive AF

If the subject approaches or retreats from the camera at a constant rate, the camera tracks the subject and predicts the focusing distance immediately before the picture is taken. This is for obtaining correct focus at the moment of exposure.

With a manually selected focusing point, the focusing point will flash in red and focus track the subject.

When the focusing point selection is automatic, the camera first uses the center focusing point to focus. If the subject later moves away from the center focusing point, focus tracking continues as long as the subject is covered by another focusing point in the Area AF ellipse. The active focusing point does not light.

C.Fn With Custom Function C.Fn-4-2, you can lock the focus momentarily by pressing the **< * >** button even while the AI Servo AF is active. (→p.100)

C.Fn Custom Function C.Fn-11-2 enables you turn the **< 0 >** dial to change the focusing point to track the subject in the AI Servo AF mode. (→p.105)

Area AF Ellipse and Focusing Points

The Area AF ellipse is the area where the camera can focus the subject. The Area AF ellipse has 45 focusing points, making autofocus possible over a wide area in the viewfinder. You can concentrate on composing the picture without worrying about whether a focusing point is covering the subject. As long as the subject is within the Area AF ellipse, the camera will focus the subject automatically.

Focusing points in the Area AF ellipse

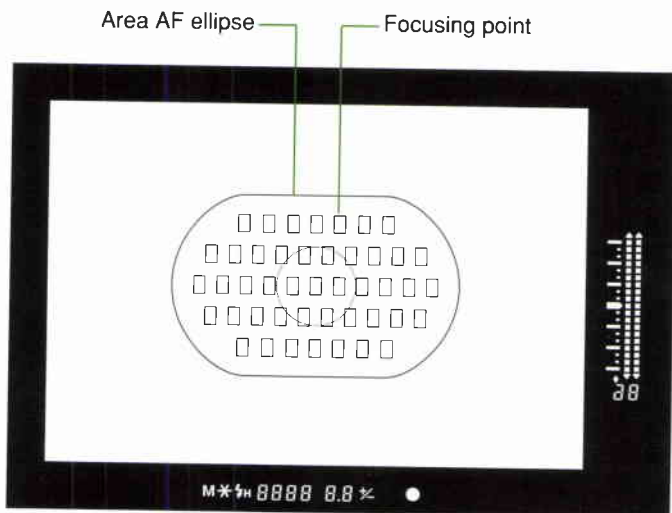

Everything is displayed above. Normally, only part of the above is displayed.

Focusing Point Selection

The focusing point can be selected automatically or manually.

• Automatic Selection

From among the 45 focusing points, the camera selects the focusing point automatically to suit the subject.

• **Manual Selection** (One of three groups of selectable focusing points can be used)

(1) You can select one of the 45 focusing points manually.



(2) You can select one of eleven focusing points (C.Fn 13-1/2)

(3) You can select one of nine focusing points (C.Fn 13-3)

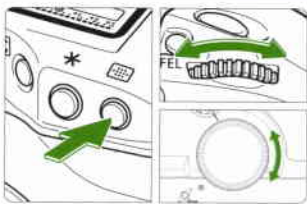

* C.Fn-13 enables (2) and (3). To set a Custom Function, see "Selecting and Setting Custom Functions" on page 96.

Basic Procedure for Focusing Point Selection









- To select a focusing point, press the  button, then turn the  or  dial.

Selecting a horizontal focusing point

- Press the  button and turn the  dial.
- The selected focusing point will shift horizontally.

Selecting a vertical focusing point

- Press the  button and turn the  dial.
- To select a vertical focusing point, you can also press the  button, then hold down the  button and turn the  dial.
- The selected focusing point will shift vertically.
- The camera will be ready for picture-taking when the shutter button is pressed halfway or when  elapses.

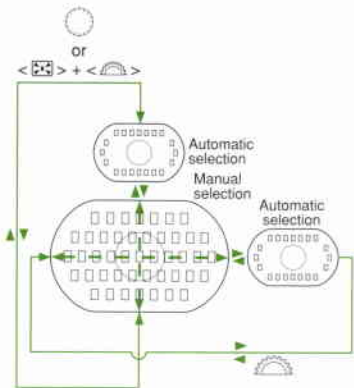

Automatic Selection

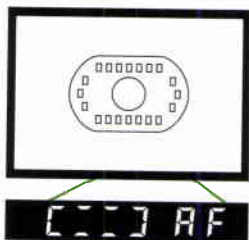

Press the button and turn the dial.

- Turn the dial until the viewfinder display is as shown on the left. You can also turn the dial.
- While in the manual selection mode, shifting the focusing point beyond the peripheral focusing point will set the automatic selection mode. The automatic selection mode can also be set while C.Fn-13-1/2/3 has been set.

Manual Selection

(1) Manual selection of 45 focusing points

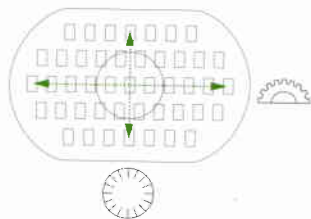

- Select the focusing point as described in “Basic Procedure for Focusing Point Selection.”
- When a vertical focusing point is selected, the selection will alternate between one () and double focusing points ().

Center focusing point selected.

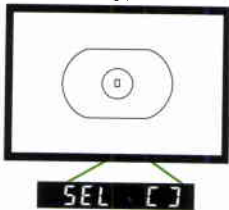

Off-center focusing point selected.

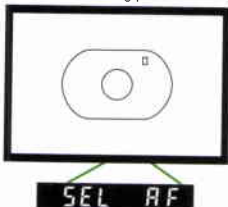

Double focusing points selected.

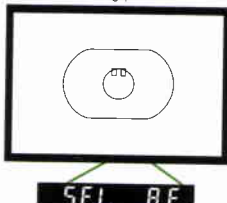

If double focusing points are selected, focusing point selection will be automatic with both focusing points. If you then select the left or right focusing point, only that focusing point will be active.

(2) Manual selection limited to 11 focusing points **C.Fn-13-1/2** (→p.106)

Since the selectable focusing points are limited to 11, you can better concentrate on framing the subject. Although you select the focusing point in the same way as with the 45 focusing points, having fewer selectable focusing points makes it faster to select a focusing point. (→p.106)

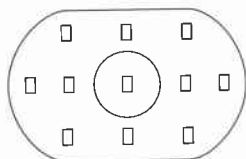

- You can select one of 11 focusing points.
- Select the focusing point as described in "Basic Procedure for Focusing Point Selection."

C.Fn C.Fn-13-1 enables spot metering to be linked to the selected focusing point. (→p.52, 106)

(3) Manual selection limited to 9 focusing points **C.Fn-13-3** (→p.106)

The center focusing point and 8 peripheral focusing points are selectable. Turning the Quick Control Dial makes it very fast to select one of the 8 peripheral focusing points. (→p.106)

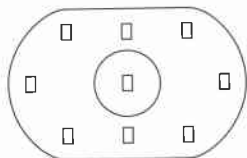

- You can select one of 9 focusing points.
- Select a horizontal focusing point as described in "Basic Procedure for Focusing Point Selection." While in the manual selection mode, shifting the focusing point beyond the peripheral focusing point will set the automatic selection mode.

Selecting a peripheral focusing point

- Press the button and turn the dial.
- Turn the to quickly select a peripheral focusing point.

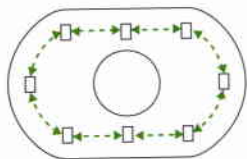

C.Fn A peripheral focusing point can also be selected with the dial alone. (C.Fn-11-2→p.105)

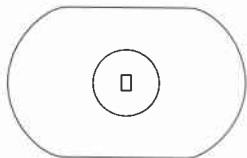

Selecting the center focusing point

- Press the  button and press the  button.
- The center focusing point will be selected.









When you select spot metering, it will be linked to the selected focusing point. (→p.52)



With C.Fn-18, you can select the center focusing point by pressing (and releasing) or holding down the  button. (→p.109)



The manual selection method can be altered as follows:

- (1) C.Fn-11-1 gives the  button the function of the  button. (→p.105)
- (2) C.Fn-11-2 gives the  button the function of the  button. The  dial can also be used by itself. (→p.105)
- (3) C.Fn-11-2 can switch manual focusing point selection to automatic selection. (→p.105)
- (4) C.Fn-11-3 gives the  button the function of the  button. (→p.105)

Focusing Point Registration and Switching

By registering the focusing point you often use, you can switch to it instantly. You can register an off-center focusing point which suits your preferred framing or the picture-taking moment. Any of the 45 focusing points can be registered. Only one focusing point can be registered.

Registering a Focusing Point

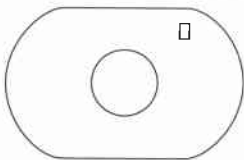

- 1 Press the button which remains active for (06). Then turn the or dial to select the focusing point to be registered.

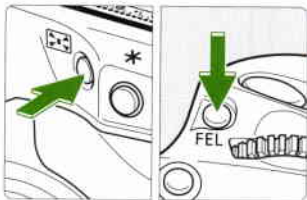

- 2 While pressing the button, press the button.
 - This registers the selected focusing point.
 - When the focusing point is registered, the LCD panel display will differ depending on the selected focusing point. The same display will also appear when the registered focusing point is selected.

Automatic selection

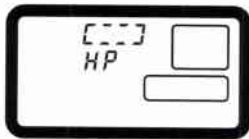

HP

Off-center focusing point



SEL HP

Center focusing point

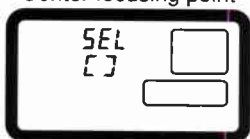

SEL C]

⚠ When using a Speedlite, first press the button. If you press the button first, flash exposure lock will take effect and the focusing point selection will be canceled.



- A focusing point can be registered even when C.Fn-13-1/2 has been set to limit the selectable focusing points to 11. (→p.106)
- When C.Fn-13-3 has been used to limit the selectable focusing points to 9, a focusing point cannot be registered. (→p.106)
- "SEL" stands for Select, and "HP" stands for "Home Position."

Switching to the Registered Focusing Point

Normally, you press the **<Fn>** button and **<MFn>** button simultaneously to switch to the registered focusing point. However, with C.Fn-18-1/2 (→p.109), you can just press the **<Fn>** button to switch to the registered focusing point. See "Setting Custom Functions" on page 96.

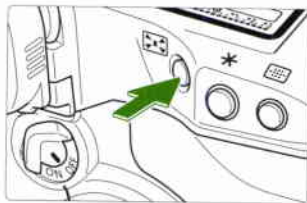

(1) Press only the **<Fn> button to switch to the registered focusing point. C.Fn-18-1 (→109)**

(2) Switch to the registered focusing point only while pressing the **<Fn>. C.Fn-18-2 (→109)**

- When the **<Fn>** is released, it will return to the original focusing point.

(3) Press the **<Fn> button and **<MFn>** button simultaneously.**

- This is the default method with C.Fn-18-0.

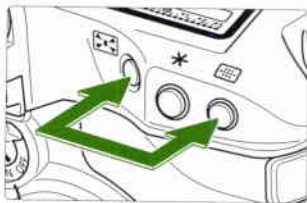

If no focusing point has been registered, the above steps will switch it to the center focusing point.



If C.Fn-18-1/2 and C.Fn-4-1/3 have been set, you can press only the **<Fn>** to switch to the registered focusing point and start autofocus at the same time.

Focusing Point Activation Area **C.Fn-17**

C.Fn-17 can be set to expand the focusing point's activation area to include more than one active focusing point. (→p.108)

• C.Fn-17-1 Expanding the activation area to 7 points **C.Fn-17-1** (→p.108)

This larger activation area makes it easier to focus subjects moving irregularly.

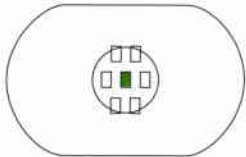

- : Selected focusing point.
- : Focusing points in expanded activation area.

- The expanded focusing point activation area is not displayed in the viewfinder.
- When focus is achieved in the One-Shot AF mode, the selected focusing point and the focusing point(s) achieving focus will light.

• C.Fn-17-2 Expanding the activation area to 7 or 13 points automatically **C.Fn-17-2** (→p.108)

As shown below, the focusing point activation area expands automatically to 7 or 13 points depending on the lens focal length, AF mode, and the subject's speed in the AI Servo AF mode. This is effective when the subject's movement is unpredictable.

AF Mode	Lens Focal Length	
	Shorter than 300mm	300mm or Longer
One-Shot AF	<p>The activation area does not expand automatically.</p>	<p>The activation area expands by one point.</p>
AI Servo AF	<p>For a slow-moving subject For a fast-moving subject</p>	<p>For a slow-moving subject For a fast-moving subject</p>

* To set the Custom Function, see "Selecting and Setting Custom Functions" on page 96.

Focusing an Off-Center Subject

To focus a subject not covered by the Area AF ellipse, follow the procedure below. This technique is called focus lock.

- Focus lock works only in the One-Shot AF mode. (→p.35)

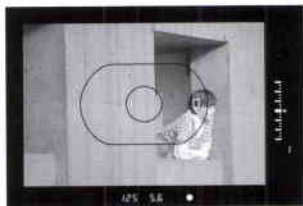

- 1 Aim the focusing point on the subject and press the shutter button halfway to focus.

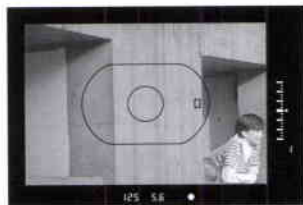

- 2 Keep pressing the shutter button halfway and recompose the picture as desired.

- 3 Take the picture.



Evaluative metering is recommended with the One-Shot AF mode which locks the autoexposure setting when focus is achieved.



AF Sensitivity According to the Lens' Maximum Aperture

The EOS-1V's focusing points are all horizontal-line sensitive. However, depending on the maximum aperture of the lens, certain focusing points can achieve higher AF precision.

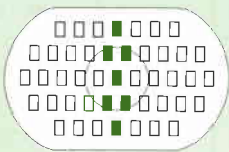

- (1) With lenses whose maximum aperture is $f/2.8$ or larger, the focusing points highlighted in the figure become cross-type sensors sensitive to both vertical and horizontal lines. The remaining 38 focusing points are horizontal-line sensitive. The sensor's vertical-line sensitivity is three times higher than the horizontal-line sensitivity. With lenses whose maximum aperture is $f/3.5$ or darker, all 45 focusing points will be horizontal-line sensitive except with the L-series lenses listed in (2) below.

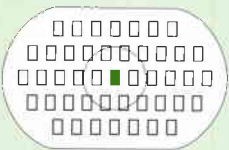

- (2) With the following Extenders and L-series lenses whose maximum aperture is brighter than $f/4$, high-precision AF is possible with the center focusing point working as a cross-type sensor. The remaining 44 focusing points are horizontal-line sensitive (except with EF 70-200mm $f/2.8L$ USM + Extender EF 1.4x).

- EF 28-80mm $f/2.8-4L$ USM
- EF 300mm $f/4L$ USM
- EF 300mm $f/4L$ IS USM
- EF 500mm $f/4L$ IS USM
- EF 600mm $f/4L$ USM
- EF 600mm $f/4L$ IS USM
- EF 70-200mm $f/4L$ USM
- With Extender EF 1.4x:
 - EF 200mm $f/2.8L$ USM
 - EF 200mm $f/2.8L$ II USM
 - EF 300mm $f/2.8L$ USM
 - EF 300mm $f/2.8L$ IS USM
 - EF 400mm $f/2.8L$ USM
 - EF 400mm $f/2.8L$ II USM
 - EF 400mm $f/2.8L$ IS USM
- With Extender EF 2.0x:
 - EF 135mm $f/2L$ USM
 - EF 200mm $f/1.8L$ USM



(3) With the following Extenders and L-series lenses whose maximum aperture is brighter than $f/8$, the center focusing point will be sensitive to horizontal lines only. The other focusing points cannot be used for AF.

- With Extender EF 1.4x:
 - EF 400mm $f/5.6$ L USM
 - EF 500mm $f/4.5$ L USM
 - EF 100-400mm $f/4.5-5.6$ L IS USM
- With Extender EF 2.0x:
 - EF 300mm $f/4$ L USM
 - EF 300mm $f/4$ L IS USM
 - EF 500mm $f/4$ L IS USM
 - EF 600mm $f/4$ L USM
 - EF 600mm $f/4$ L IS USM
 - EF 70-200mm $f/4$ L USM
- When the  button is pressed, the display shown on the right appears on the LCD panel.

AF

When Autofocus Fails (Manual Focusing)

Autofocus can fail to achieve focus (the in-focus indicator blinks) with certain subjects such as the following:

- (a) Low-contrast subjects (blue sky, solid-color walls, etc.).
- (b) Subjects in low light.
- (c) Extremely backlit or reflective subjects (car with a reflective body, etc.).
- (d) Overlapping near and far objects (animal in a cage, etc.).

In such cases, do one of the following:

1. Focus an object at the same distance as the subject and lock the focus before recomposing.
2. Set the lens focus mode switch to **MF** (or **M** on older lenses) and focus manually.

 If focus cannot be achieved with the AF-assist light of a Speedlite or ST-E2, select the center focusing point. An off-center focusing point might not be able to achieve focus.

Manual Focusing

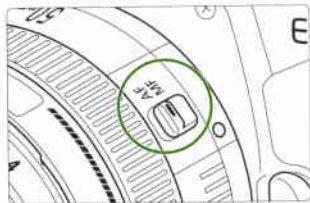

1 Set the lens focus mode switch to **MF** (or **M** on older lenses).

- The AF mode indicator on the LCD panel turns off.





2 Focus by turning the lens focusing ring until the subject is in focus in the viewfinder.

- Select the desired focusing point and press the shutter button halfway while manual focusing. When focus is achieved, the selected focusing point will flash and the in-focus indicator will light.
- When the focusing point is selected automatically and the center focusing point achieves focus, it will flash and the in-focus indicator will light.
- With USM (Ultrasonic Motor) lenses (except those not having a distance scale), you can use the focusing ring to fine focus after focus is achieved in the One-Shot AF mode (full-time manual focusing).

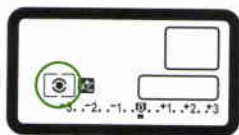
C.Fn For USM lenses with an electronic focusing ring (such as the EF 200mm f/1.8L), Custom Function C.Fn-7 can require the lens focus mode switch to be set to **MF** (or **M**) before manual focus is enabled. (→p.102)

Evaluative, partial, spot, and centerweighted averaging metering modes are provided. Center spot metering, focusing point-linked spot metering, and multi-spot metering can also be set. Select the metering mode that suits the subject or your photographic intention.



-  Evaluative metering
-  Partial metering
-  Spot metering
-  Centerweighted averaging metering

Metering Modes

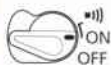

First set the  switch to <ON>.

Selecting a Metering Mode

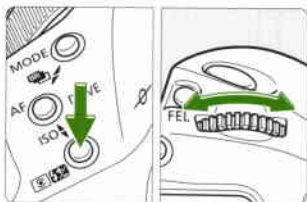

1 While pressing the button, turn the dial until the desired metering mode icon appears.

- Evaluative
- Partial
- Spot
- Centerweighted averaging

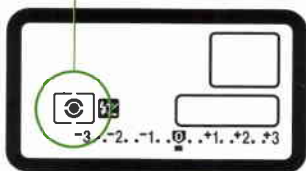

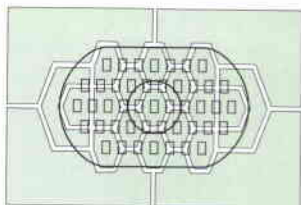

2 Release the button.

Metering Modes



Evaluative Metering

This is an all-around metering mode suited even for backlit subjects. The viewfinder is divided into 21 metering zones to which all the focusing points are linked for evaluative metering. After detecting the main subject's size, position, brightness, background, front and back lighting, etc., the camera sets the proper exposure.

- During manual focusing, evaluative metering is based on the center focusing point.
- If the subject brightness and background light level are very different (there is a strong backlight or spotlight), use partial metering () or spot metering () instead.

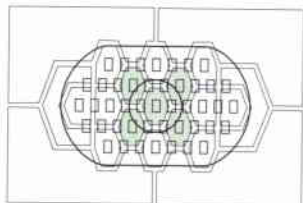

Partial Metering

This mode is effective when the background is much brighter than the subject (due to backlighting, etc.). The metering is weighted at the center covering 8.5% of the viewfinder area.

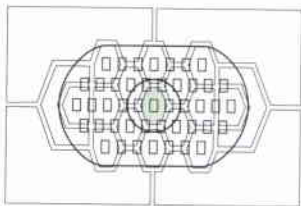

Spot Metering

This is for metering a particular part of the subject or scene. The metering is weighted at the center covering 2.4% of the viewfinder area.

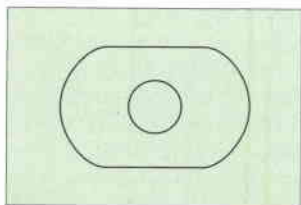

Centerweighted Averaging Metering

The metering is weighted at the center and then averaged for the entire scene.

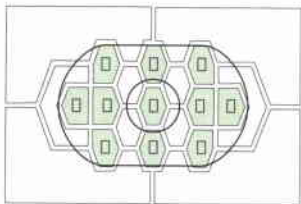

Focusing Point-Linked Spot Metering

To make focusing point selection faster, the selectable focusing points can be limited to 11 (C.Fn-13-1) or 9 (C.Fn-13-3). When C.Fn-13-1 or C.Fn-13-3 has been set, the manually-selected focusing point is linked to 2.4% spot metering. (→p.40, 41, 106)



During continuous shooting in the spot metering mode, AE lock is set automatically without the **< * >** indicator displayed in the viewfinder.

C.Fn

C.Fn-13-2 can limit the manually-selectable focusing points to only 11 while keeping the spot metering linked to the center focusing point. (→p.40, 106)

Multi-Spot Metering

Multiple spot meter readings can be taken and then averaged automatically. As shown in the sample below, you can take multiple spot meter readings.



1 Set the spot metering mode.
(→p.50)

2 Aim the focusing point over the shadow area and press the <FEL> button.

- This obtains the first spot meter reading.

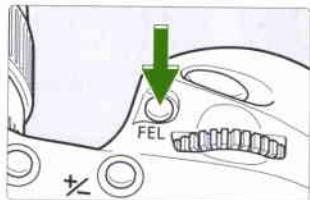

3 Aim the focusing point over a midtone area and press the <FEL> button once. Then do the same for a highlight area.

- Each time a spot meter reading is taken, the spot meter readings taken so far are averaged and the result (shutter speed and aperture) is displayed below the viewfinder. See the figure in "Multi-Spot Metering Display" on the next page. On the exposure compensation scale on the right of the viewfinder, the exposure level indicator moves around in real-time to indicate the spot meter reading's current exposure level. The three spot meter readings are also indicated on the scale with a fixed (non-moving) metering mark.

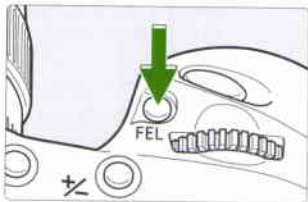

Multi-Spot Metering Display

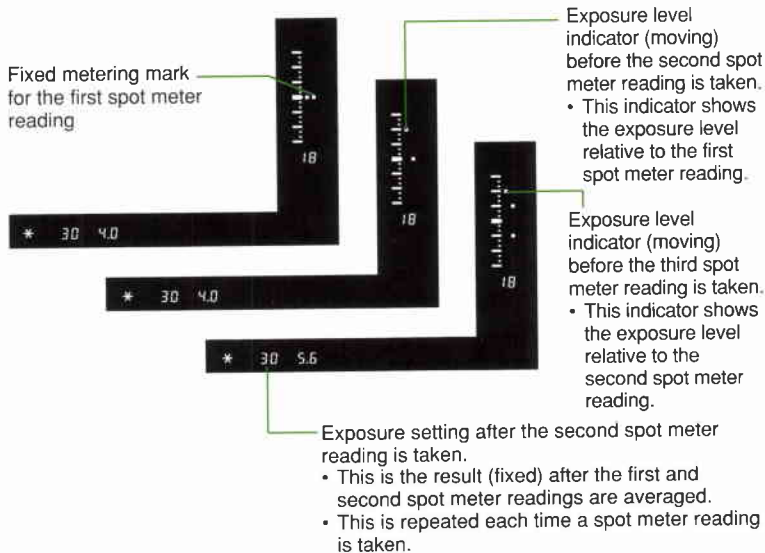

- The exposure settings obtained with multi-spot meter readings are canceled in the following cases:
 1. After taking the last spot meter reading, 16 seconds elapse.
 2. You press the $\langle \text{FEL} \rangle$, $\langle \text{MODE} \rangle$, or $\langle \text{AF} \rangle$ button.
 3. After taking the picture, you take your finger off the shutter button.

 Up to eight spot meter readings can be taken for one picture. If you press the $\langle \text{FEL} \rangle$ button to try and take a ninth spot meter reading, no spot meter reading will register.

 Multi-spot metering can be fixed at the center or linked to the active focusing point with C.Fn-13 (\rightarrow p.106).

You can set the shooting mode that best suits the subject or your objective. You can also easily achieve various photographic effects.

- M** : Manual (→65)
- Tv** : Shutter speed-priority AE (→56)
- DEP** : Depth-of-field AE (→61)
- Av** : Aperture-priority AE (→58)
- bulb (→76)
- Multiple exposures (→74)
- AEB (→69)
-  : Film advance (→77)

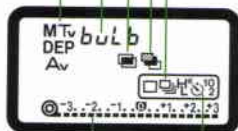

 : self-timer (→79)

Exposure compensation (→67)



Shooting Modes



First set the $\langle \text{ON/OFF} \rangle$ switch to $\langle \text{ON} \rangle$. If necessary, also set the $\langle \text{ON/OFF} \rangle$ switch to $\langle \text{ON} \rangle$.

Tv Shutter Speed-Priority AE

In this mode, you set the desired shutter speed and the camera sets the aperture automatically to suit the subject brightness.

A fast shutter speed can freeze motion, and a slow shutter speed can achieve a blurred effect.

* Tv is an abbreviation for Time value.



With a fast shutter speed



With a slow shutter speed

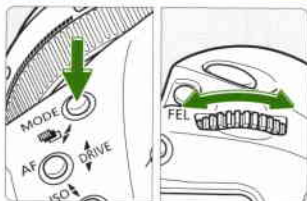

- 1 While pressing the <MODE> button, turn the <  > dial until Tv appears on the LCD panel. Then release the <MODE> button.

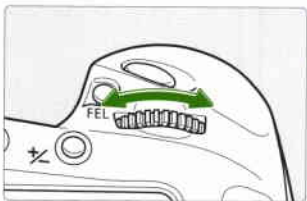
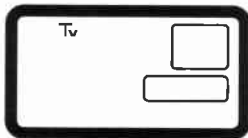

- 2 Turn the <  > dial to set the desired shutter speed.

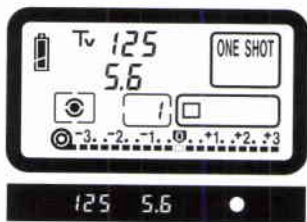

3 Press the shutter button halfway and focus the subject.

- ▶ The shutter speed and aperture will be displayed.

4 Take the picture.

- As long as the aperture display is not blinking, a correct exposure will be obtained.

Exposure Warnings

- If the lens' maximum aperture (smallest f-number like f/1.4) blinks, it indicates underexposure. Turn the <  > dial to set a slower shutter speed until the aperture display stops blinking.



- If the lens' minimum aperture (largest f-number like f/22) blinks, it indicates overexposure. Turn the <  > dial to set a faster shutter speed until the aperture display stops blinking.



C.Fn C.Fn-16 enables the safety shift feature. (→108)

In the shutter speed-priority AE mode, if a correct exposure cannot be obtained with any aperture set by the camera, the camera automatically sets a faster or slower shutter speed. This feature is called safety shift.

C.Fn C.Fn-6 enables the shutter speed to be set in full-stop or 1/2-stop increments instead of the standard 1/3-stop increments. (→102)

Av Aperture-Priority AE

In this mode, you set the desired aperture and the camera sets the shutter speed automatically to suit the subject brightness.

The larger the aperture (smaller f-number) the more blurred the background will become. This effect is suited for portraits. The smaller the aperture (larger f-number), the clearer the focus will be for both near and far objects.

* Av is an abbreviation for Aperture value.



With a large aperture

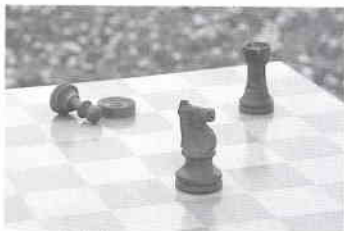

With a small aperture

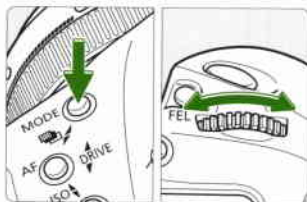

- 1 While pressing the <MODE> button, turn the <  > dial until Av appears on the LCD panel. Then release the <MODE> button.



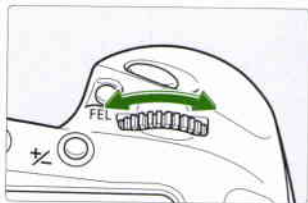

- 2** Turn the <  > dial to set the desired aperture.

- 3** Press the shutter button halfway and focus the subject.

▸ The shutter speed and aperture will be displayed.

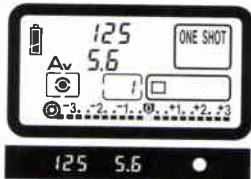

- 4** Take the picture.
- As long as the shutter speed is not blinking, a correct exposure will be obtained.
 - If the shutter speed is slower than the reciprocal of the lens focal length (i.e. 1/200 for a 200mm lens), camera shake may cause a blurred picture.

Exposure Warnings

- If the 30" shutter speed blinks, it indicates underexposure. Turn the <  > dial to set a larger aperture (smaller f-number) until the shutter speed stops blinking.



- If the 8000 shutter speed blinks, it indicates overexposure. Turn the <  > dial to set a smaller aperture (larger f-number) until the shutter speed stops blinking.



C.Fn C.Fn-16 enables the safety shift feature. (→p.108)

If a correct exposure cannot be obtained in the aperture-priority AE mode with any shutter speed set by the camera, the camera automatically sets a larger or smaller aperture. This feature is called safety shift.

C.Fn C.Fn-6 enables the aperture to be set in full-stop or 1/2-stop increments instead of the standard 1/3-stop increments. (→p.102)

C.Fn For aperture-priority AE, C.Fn-5-2/3 enables the aperture to be set with the camera even while the lens is detached. (→p.101)

DEP Depth-of-field AE

This mode is effective when you want a wide depth of field to keep everything in focus near and far. The optimum point of focus and aperture to attain the required depth of field are set automatically along with the shutter speed.

- To use this mode, the lens focus mode switch must be set to **AF**.

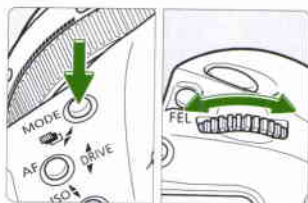

- 1 While pressing the **<MODE>** button, turn the **<DIAL>** dial until **DEP** appears on the LCD panel. Then release the **<MODE>** button.

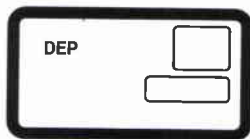

- 2 Press the **<DIAL>** button and turn the **<DIAL>** or **<DIAL>** dial to select the desired focusing point.



3 Aim the selected focusing point at the nearest subject you want in focus, then press the shutter button. (Ⓞ6)

- The in-focus indicator lights and *dEP 1* is displayed.
- If two focusing points are active (→p.43), both focusing points will be used for depth-of-field AE.



4 Use the same focusing point to aim at the farthest subject you want in focus and press the shutter button. (Ⓞ6)

- The in-focus indicator lights and *dEP 2* is displayed.
- You can also reverse the above two steps.



5 Compose the picture and press the shutter button halfway to check that the shutter speed and aperture are not blinking. (Ⓞ6)

- The point of focus is set between the two *dEP* points. The aperture required to achieve the desired depth of field and a suitable shutter speed are set automatically.
- If you release the shutter button, *dEP* and the aperture will be displayed.
- The exposure setting is set when the picture is taken.



6 Take the picture.

Exposure Warnings

- If the aperture blinks, the desired depth of field cannot be obtained. (However, you can still take the picture and obtain a proper exposure.) Use a wide-angle lens or move away from the subject and repeat steps 3 to 5.
- If the 30" shutter speed and the lens' maximum aperture (smallest f-number) blink, the scene is too dark and the picture cannot be taken in the depth-of-field AE mode.
- If the 8000 shutter speed and the lens' minimum aperture (largest f-number) blink, the scene is too bright. Use a neutral density (ND) filter to reduce the amount of light entering the camera.



- When using a zoom lens, do not change the zoom focal length while using the depth-of-field AE mode.
- After setting **one or two dEP** points, do not change the active focusing point. Doing so **will cancel the dEP point(s)** that has been set and you will have to start over **with the newly selected** focusing point.
- If flash is **used with the depth-of-field AE mode**, the result will be the same as using Program AE with flash.
- If depth-of-field AE is used with a lens having a focusing limiting switch (like the EF 300mm f/2.8 IS USM lens), set the switch to the maximum focusing distance range.

-  • With automatic focusing point selection in the depth-of-field AE mode, only the center focusing point will be used for focusing.
- If a slow shutter speed has been set, use a tripod to prevent camera shake.
- If six seconds elapse before you complete the DEP procedure, the DEP point(s) set so far will be canceled. In such a case, you must start over again.
- To cancel the depth-of-field AE mode midway, press the <MODE> button, <AF> button, or < > button.

-  • To further increase the depth of field, use a wide-angle lens.
- Setting dEP points 1 and 2 at the same point on the subject will make the depth of field shallow. The foreground and background will then be blurred, making the subject stand out. Using a telephoto lens enhances this effect.

M Manual Exposure

In this mode, you set both the shutter speed and aperture for total exposure control. You can refer to the exposure level indicator in the viewfinder or use a handheld exposure meter to determine the shutter speed and aperture.

Using the Built-in Exposure Meter

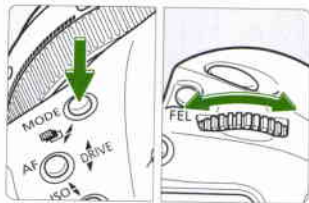

- 1** While pressing the <MODE> button, turn the <☀> dial until **M** appears on the LCD panel. Then release the <MODE> button.

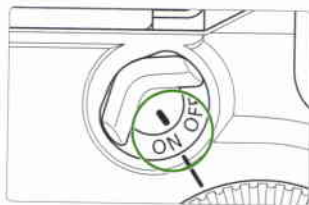
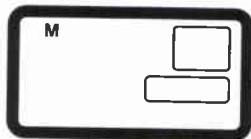

- 2** Set the <☞> switch to <ON>.

- 3** Turn the <☀> dial to set the shutter speed and turn the <☉> dial to set the aperture.
- To set the aperture, you can also press the <⚡> button and turn the <☀> dial.



Exposure level indicator

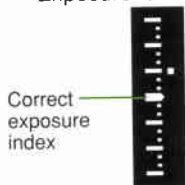

4 Focus the subject.



- ▶ The shutter speed and aperture will be displayed.
- ▶ On the right of the viewfinder, the exposure level indicator indicates the current exposure level relative to the correct exposure index.

5 Refer to the exposure level indicator and set the shutter speed and aperture to obtain the desired exposure level.

6 Take the picture.



- C.Fn** C.Fn-5 can reverse the functions of the <☀> dial and <⊙> dial. (→p.101)
- C.Fn** C.Fn-6 can set the shutter speed and/or aperture increments to full stops or half stops instead of the standard 1/3 stops. (→p.102)
- C.Fn** C.Fn-5-2/3 enables the aperture to be set manually even when the lens has been detached. (→p.101)

Setting Exposure Compensation

Exposure compensation is used to alter the camera's standard exposure setting. To set the exposure compensation amount, you can either turn the  dial while looking through the viewfinder or press the  button and turn the  dial while looking at the LCD panel. The exposure compensation amount can be set up to ± 3 stops in 1/3-stop increments.

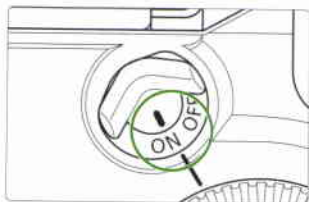
Exposure Compensation with the Dial









- 1 Set the  switch to <ON>.
- 2 Focus the subject and check the exposure level.
- 3 Turn the  dial to set the desired exposure compensation amount.



Overexposure.



Underexposure.

- The exposure compensation icon () and the exposure level indicator () will be displayed in the viewfinder, while the exposure level indicator () will be displayed on the LCD panel.
- Turn the  dial while pressing the shutter button halfway or within () after releasing the shutter button.
- On the viewfinder's exposure level scale, any position above the correct exposure index indicates overexposure and any position below it indicates underexposure. On the LCD panel, any position on the + side indicates overexposure and any position on the - side indicates underexposure.
- To cancel exposure compensation, set the amount to the correct exposure index ( or ).

- 4 Take the picture.

Setting Exposure Compensation

C.Fn Custom Function C.Fn-6-2 enables the exposure compensation amount to be set in 1/2-stop increments. (→p.102)

The exposure compensation amount's 1/2-stop increments enabled with C.Fn-6 are indicated in the viewfinder and on the LCD panel as shown below.

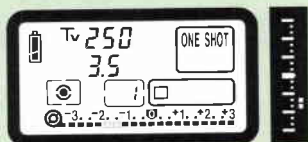

-1 1/2 exposure compensation

Exposure Compensation with the \pm Button and ☀ Dial

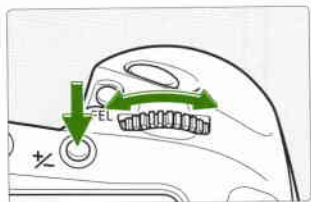

2 Press the \pm button and turn ☀ dial within (☉) to set the desired exposure compensation amount.

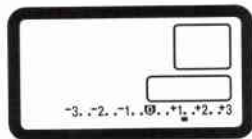

- The exposure compensation amount will remain in effect even after the ☉ switch is set to <OFF>.
- To prevent the ☉ dial from turning inadvertently and changing the exposure compensation amount, set the ☉ switch to <OFF>.

Autoexposure Bracketing

With autoexposure bracketing, the camera automatically changes the exposure level within the set range (up to ± 3 stops in 1/3-stop increments) for three successive frames. The three bracketed shots are exposed in the following sequence: correct exposure, underexposure, and overexposure. The current film advance mode (see "Switching the Film Advance Mode" on page 77) is used during the bracketing.



Correct exposure (0)



Underexposure ($-1/3$ stop)



Overexposure ($+1/3$ stop)

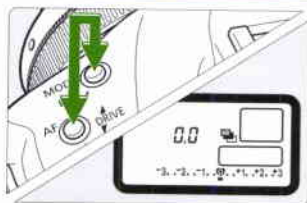

1 Press the <MODE> button and <AF> button simultaneously.

- The  AEB icon appears on the LCD panel.

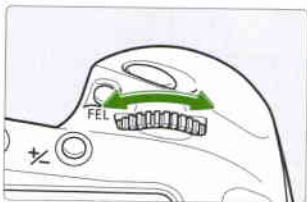

2 Turn the <AEB> dial to set the desired bracketing amount.

- On the LCD panel, the bracketing amount is indicated in stops and the bracketing range is shown on the exposure compensation scale. The display shows a bracketing amount of ± 1 stop centering on the correct exposure level.

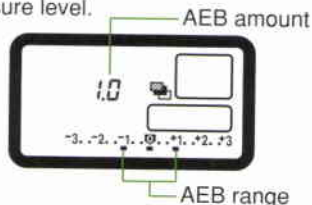

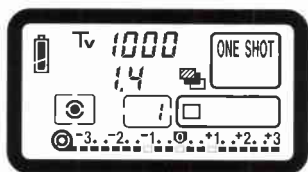



Display for ± 1 -stop AEB.

3

Take the pictures.

- The current film advance mode will be used.
- The viewfinder's exposure level scale will show the respective bracketing amount as each bracketed shot is taken.
- In the continuous shooting mode, holding down the shutter button will take all three bracketed shots continuously. The shooting will then stop automatically.
- When AEB is used with the self-timer, the three bracketed shots will be taken in succession after the 2- or 10-second self-timer delay.



- To indicate that AEB is in progress, the  AEB icon on the LCD panel and  indicator in the viewfinder will blink until all the bracketed shots are taken.
- In the manual exposure mode, AEB will proceed by changing the shutter speed.

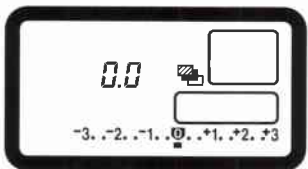

Canceling AEB

- Follow steps 1 and 2 to set the AEB to **0.0**.
- AEB will also be canceled by changing lenses, rewinding the film, replacing the film, setting a bulb exposure, having a flash-ready Speedlite, pressing the **< CLEAR >** button, and setting the **<  >** switch to **< OFF >**.



- No viewfinder information will be displayed during continuous shooting of the bracketed shots.
- After setting the AEB amount, you can also set exposure compensation to obtain underexposed or overexposed bracketing. See "Setting Exposure Compensation" on page 67.
- AEB cannot be used together with bulb exposures or flash.
- If mirror lockup has been set with C.Fn-12 and AEB is used, single-frame shooting will take effect even if the film advance mode is set to continuous shooting.

- C.Fn** C.Fn-6-2 enables the AEB amount to be set in 1/2-stop increments. (→p.102)
- C.Fn** C.Fn-9-2/3 can change the bracketing sequence to underexposure, correct exposure, and overexposure. (→p.104)
- C.Fn** C.Fn-9-1/3 can prevent AEB from being canceled by changing lenses, rewinding the film, replacing the film, and setting the $\langle \text{AE} \rangle$ switch to $\langle \text{OFF} \rangle$. (→p.104)
- C.Fn** C.Fn-5-1 can have the aperture change instead of the shutter speed during AEB in the manual exposure mode. (→p.101)

AE Lock

AE lock enables you to lock the exposure at a different place from the point of focus. After locking the exposure, you can recompose the shot while maintaining the desired exposure level. This feature is useful for backlit and spotlighted subjects.



1 Focus at the point where you want to lock the exposure reading.

- The exposure setting (shutter speed and aperture) will be displayed on the LCD panel and in the viewfinder.

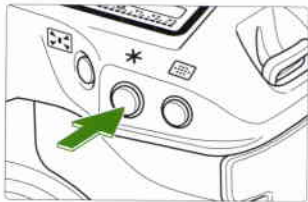

2 Press the $\langle * \rangle$ button (06).

- $\langle * \rangle$ lights in the viewfinder to indicate that the exposure setting is locked.
- Each time you press the $\langle * \rangle$ button, it locks the current exposure setting.
- AE lock cancels 6 seconds after $\langle * \rangle$ lights in the viewfinder or if you press the $\langle \text{AF} \rangle$ button, $\langle \text{AE} \rangle$ button, or $\langle \text{MODE} \rangle$ button.



AE lock indicator

3 Recompose the shot and take the picture.

- When the shot is recomposed, the exposure level indicator will show the new exposure level in real-time relative to the locked exposure level.



AE lock exposure level

Real-time exposure level

 Partial or spot metering is recommended for AE lock over a specific point. (→p.51)

 If One-Shot AF and evaluative metering are set, pressing the shutter button halfway to focus will automatically set AE lock at the same time.

C.Fn C.Fn-4-1 enables AE lock with the shutter button pressed halfway (instead of the < * > button) and focusing with the < * > button. (→p.100)

Setting the Film Speed Manually

If the film is not DX-coded or if you want to set a different ISO film speed, you can load the film and set the ISO film speed manually.

- The ISO film speed can be set manually from 6 to 6400.

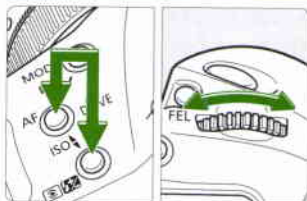

1 Press and hold down the < AF > button and < [ISO] > button simultaneously.

- The ISO icon and the currently-set film speed will be displayed.

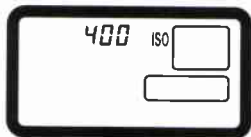

Difference relative to the correct ISO film speed

Manually-set ISO film speed

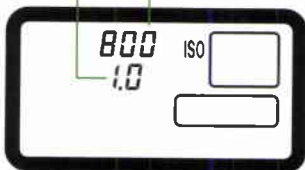

2 Turn the < [DIAL] > dial until the desired film speed is displayed on the LCD panel.

- With DX-coded film, the difference in stops relative to the correct ISO speed is displayed.

This sample display indicates that ISO 400 film has been manually set to ISO 800. This is also displayed when the film starts rewinding and until the film cartridge is taken out.

3 Release the two buttons.

- The film speed will then be set.

 The manually-set film speed will be canceled the next time DX-coded film is loaded.

C.Fn C.Fn-3 can prevent the manually-set film speed from being canceled the next time DX-coded film is loaded. (→p.99)

Multiple Exposure

By not advancing the film, a single frame can be exposed multiple times. Up to nine multiple exposures can be set for one frame. Multiple exposures can be taken in any shooting mode.

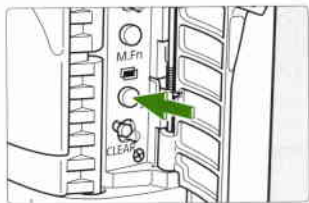

1 Open the side door and press the button.

- The  icon appears on the LCD panel and the frame counter displays “1”.

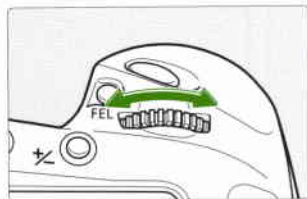
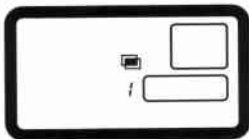

2 Turn the dial to set the desired number of multiple exposures.

- The camera will be ready to take multiple exposures when you press the shutter button halfway or after () elapse.

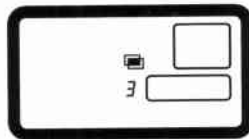



Set for 3 multiple exposures.

3 Set the shooting mode and take the pictures.

- After all the multiple exposures are taken, the film advances to the next frame and the multiple exposure setting is canceled automatically.

 If any of the film's first or last few frames is used for multiple exposures, the exposures may not align exactly due to film advance characteristics.

-  • While multiple exposures are being taken, the multiple exposure icon <  > blinks.
- To cancel the multiple exposure setting before taking multiple exposures, set the number of multiple exposures to 1.
- To cancel the multiple exposure setting after you start taking multiple exposures, follow steps 1 and 2 to set the number of multiple exposures blank.

 When taking multiple exposures, you should underexpose each multiple exposure by the amounts shown below. To underexpose, see "Setting Exposure Compensation" on page 67.

Exposure Compensation Guide for Multiple Exposures

No. of Multiple Exposures	2	3	4
Underexposure Amount of Each Exposure	-1.0 stop	-1.5 stop	-2.0 stop

These exposure compensation amounts are only general guidelines. The optimum amount depends on the scene. Experiment to find the optimum compensation amount.

Bulb Exposures

When bulb is set, the film is exposed during the time you keep pressing the shutter button completely. Bulb is useful when a long exposure is necessary for capturing night scenes, fireworks, the night sky, etc.

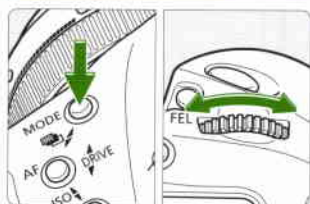

- 1 While pressing the <MODE> button, turn the <FEL> dial until *bulb* is displayed. Then release the <MODE> button.

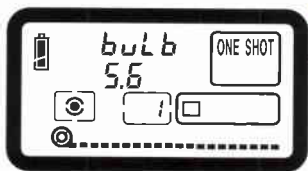
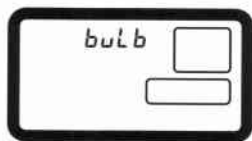

- 2 Set the <FEL> switch to <ON>, then turn the <FEL> (or <FEL>) dial to set the desired aperture.

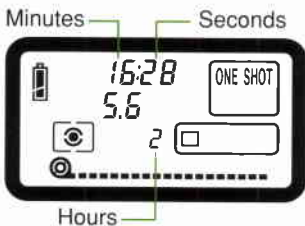

- 3 Start the bulb exposure.
 - The elapsed exposure time will be displayed on the LCD panel.
 - The bulb exposure will continue while you keep pressing the shutter button completely.

 Bulb exposures consume almost no battery power.

 Connecting the separately-sold Remote Switch RS-80N3 (with shutter release lock) or the Timer Remote Controller TC-80N3 to the camera's remote control terminal will free you from pressing the shutter button during bulb exposures.

Single-Frame and Continuous Shooting

The film advance mode can be set to single-frame shooting or continuous shooting.

Single-frame Shooting <□>

After a picture is taken, the film advances by one frame automatically.

Continuous Shooting <□>

The pictures are taken continuously while you hold down the shutter button completely.

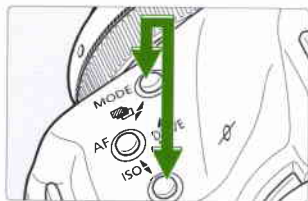

1 Press the <MODE> button and <☉> button simultaneously.

- ▶ The current film advance mode is displayed.

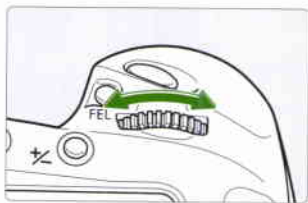
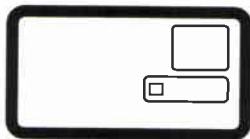







2 Turn the <☉> dial to set the desired film advance mode.



- When the desired film advance mode is selected, release the buttons.

- The shooting speeds in the table on the next page apply when the shutter speed is 1/250 sec. or faster.
- With One-Shot AF and evaluative metering set, if you stop continuous shooting by returning the shutter button to the halfway position, you can maintain the AE lock for the next time you start shooting.

When , , , , or  Blinks











If the battery power drops in cold temperatures or the film advance operation becomes slow, it means that the camera is trying to provide film advance power rather than speed. This feature is called automatic film advance transmission. If this is activated, one of the film advance icons (, , , , ) will blink on the LCD panel.

This feature is canceled when you press the <MODE> button and < > button simultaneously or when you replace the film or battery. If this feature is in effect, check the battery power (→p.20) and follow the respective countermeasures.

- If film advance or rewind stops midway,  will blink on the LCD panel. When the battery is replaced with a new one, film advance will resume. Or, to resume film rewind, press the < > button.
- In cold temperatures, warm the battery in your pocket, etc., before using.

Maximum Continuous Shooting Rates

In frames/sec. (approx.)

Configuration	Power Source	Film Advance Mode	One-Shot AF + Manual Focus	AI Servo AF
EOS-1V	2CR5 lithium battery		3.5	3
EOS-1V + BP-E1	Size-AA alkaline batteries x 4			
EOS-1V + PB-E2 (EOS-1V HS)	Nickel Hydride Pack NP-E2		10	9
			7	7
			3	3
	Size-AA alkaline batteries x 8		6	5
			3	3
			3	3
EOS-1V + Power Drive Booster E1	Size-AA alkaline batteries x 8		6	5
			3	3

 No viewfinder information is displayed during continuous shooting.

Self-timer Operation

The self-timer can be set to either a 2-second or 10-second delay. When using the self-timer, you should mount the camera on a tripod.

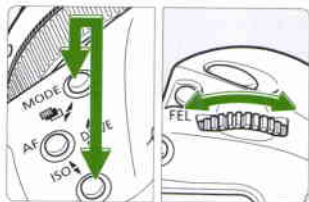

- 1** While pressing the <MODE> button and <☑> button, turn the <☀> dial and set the desired self-timer delay time.

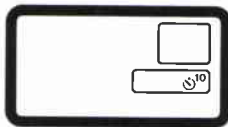

☀¹⁰ :
10-second delay
☀₂ :
2-second delay

- 2** Look through the viewfinder and press the shutter button halfway to focus.

- Check that the in-focus indicator and exposure setting are displayed.

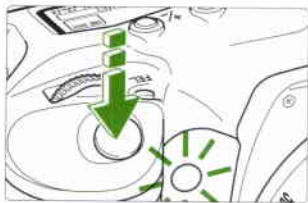

- 3** Press the shutter button completely.

- The self-timer lamp will start blinking to indicate that the self-timer has started. The lamp blinks faster during the last two seconds before the picture is taken.
- To cancel the self-timer after it starts, set the <☹> switch to <OFF>.

 When using the self-timer to photograph yourself only, first lock the focus (→p.45) on an object at about the same distance where you will be.

 The 2-second delay is effective for close-ups or photo duplicating work to prevent camera shake (camera movement while the shutter button is pressed).

 Do not stand in front of the camera when you press the shutter button to start the self-timer. Doing so will throw off the focus.

Using the Eyepiece Shutter

If you take a picture without looking through the viewfinder, stray light may enter the eyepiece and affect the exposure. To prevent this, use the built-in eyepiece shutter before taking the picture.

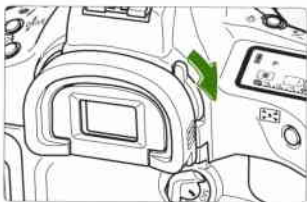

To cover the eyepiece with the eyepiece shutter, turn the lever as shown by the arrow.

To open the eyepiece shutter, turn the lever in the opposite direction.

Depth-of-field Preview

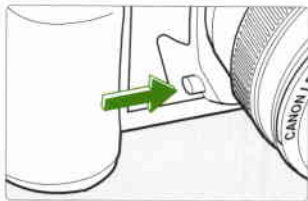

The depth of field is the range of acceptable focus in front of and behind the point of focus. The depth of field changes depending on the aperture. Press the depth-of-field preview button to stop down the aperture and preview this range of acceptable focus.

- Pressing the depth-of-field preview button also sets AE lock.
- The depth-of-field preview button does not function during AF operation.

Mirror Lockup

Mirror lockup is enabled with C.Fn-12 (→p.106). This prevents mirror-caused vibrations which may blur the image during close-ups or when a super telephoto lens is used. To set this Custom Function, see "Selecting and Setting a Custom Functions" on page 96. When mirror lockup is set, the camera operates as follows.

- When using mirror lockup, Remote Switch RS-80N3 (sold separately) is recommended.



1 Press the shutter button completely.

- The mirror locks up, and after 30 seconds, it will go back down automatically. Pressing the shutter button completely again locks up the mirror again.

2 Release the shutter button and press the shutter button completely again to take the picture.

- The picture is taken and then the mirror goes back down.

- In very bright light such as at the beach or ski ground on a sunny day, take the picture promptly after mirror lockup.
- During mirror lockup, do not point the camera lens at the sun. The sun's heat can scorch and damage the shutter curtains.
- If you use mirror lockup with the self-timer for a bulb exposure, there will be a shutter release sound when you release the shutter button during self-timer operation. This is not the sound of the shutter release.

- During mirror lockup, the film advance mode will be single-frame shooting regardless of the current film advance mode.
- If mirror lockup is used with the self-timer, pressing the shutter button completely the first time will lock up the mirror and release the shutter 10 seconds or 2 seconds later (depending on the delay time selected).

LCD Panel Illumination

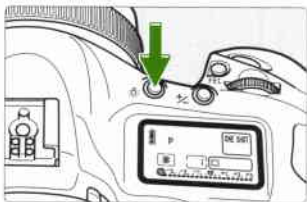

The LCD panel is provided with illumination. The LCD panel illumination button Ⓢ turns the illumination on (Ⓢ) and off. It makes the LCD panel readable in darkness. The LCD panel illumination turns off 2 seconds after a picture is taken. For a bulb exposure, the illumination turns off when the bulb exposure starts.

 Pressing any button while the LCD panel is illuminated prolongs the illumination.

Using B/W Infrared Film

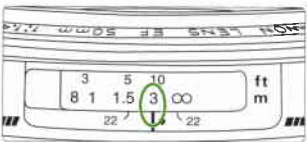

1 Focus the subject, then set the lens focus mode switch to MF (or M).

- Let's say you will focus at 3 m.

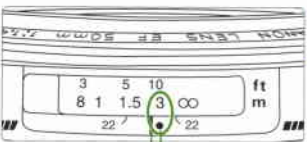

2 Use the infrared index to adjust the distance.

- Turn the focusing ring so that the focusing distance is aligned with the infrared index. If it is 3 m, align the "3" with the infrared index.

Focusing distance index — Infrared index

-  Use a lens which provides an infrared index. With L-series lenses which do not have an infrared index, there is no need to compensate for infrared film.
- It is recommended that you also take back-up pictures at slightly nearer and farther distances centering on the infrared index's distance.
 - Also refer to the infrared film's instructions.
 - Using a red filter enhances the infrared film's effects.
 - The focusing distance need not be adjusted with color infrared film.

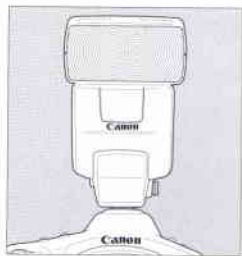

An EOS-dedicated EX-series or EZ-series Speedlite makes flash photography as easy as any AE mode. EX-series Speedlites enable E-TTL autoflash photography as well as E-TTL wireless autoflash photography with multiple Speedlites.

Speedlite 550EX will be used to describe the flash photography features provided with the EOS-1V. For details on Speedlite 550EX, see the Instructions booklet that comes with it.

6

Flash Photography



First set the <☎> switch to <ON>. If necessary, also set the <☎> switch to <ON>.

Flash Photography with Speedlite 550EX

With Speedlite 550EX, flash photography is easy as any AE mode, and you can use the following features:

- **E-TTL autoflash**

With E-TTL autoflash (preflash evaluative metering), optimum flash exposure is obtained for the subject in focus. In the aperture-priority AE mode, a slow sync speed is set automatically in low-light situations to obtain a natural-looking, balanced exposure between the subject and background.



- **High-Speed Sync (FP Flash)**

High-speed sync (FP or focal-plane flash) enables flash synchronization with all shutter speeds from 30 sec. to 1/8000 sec.

- **FE (Flash Exposure) Lock**

FE lock obtains and locks the correct flash exposure for any part of the subject. This is the flash equivalent of AE lock.

- **Flash exposure compensation**

Like normal exposure compensation, flash exposure compensation can be used to set the flash output up to ± 3 stops in 1/3-stop increments.

- **FEB (Flash Exposure Bracketing)**

As with AEB (autoexposure bracketing), flash exposures can be bracketed up to ± 3 stops in 1/3-stop increments.

- **E-TTL wireless autoflash with multiple Speedlites**

E-TTL autoflash can also be implemented with multiple wireless Speedlites. All the features listed above can be used, and no connections codes are required. Sophisticated lighting effects can be obtained as easily as using a Speedlite directly attached to the camera.

- E-TTL is an abbreviation for Evaluative-Through-The-Lens.
- With autofocus, the flash exposure is always based on the aperture (set automatically or manually) and autoflash metering is weighted at the current focusing point.
- When it is difficult to autofocus, the 550EX's built-in AF-assist beam is emitted automatically. The beam is linked to the active focusing point in the Area AF.

Full Auto Flash

Full Auto E-TTL autoflash used with the <P> Program AE mode is described here. For details on Speedlite 550EX operations, see the Speedlite 550EX Instructions booklet.

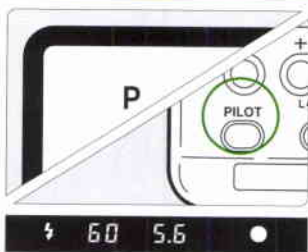

- 1 Set the camera's shooting mode to P.
- 2 Check that the 550EX's pilot lamp is lit.
- 3 Focus the subject.
- 4 Take the picture.
 - Make sure the flash-ready indicator is on, and check the shutter speed and aperture before taking the picture.

E-TTL Autoflash in Other Shooting Modes

Even in the **T_v**, **A_v**, and **M** modes, E-TTL autoflash is as easy as normal picture-taking without flash.

- (1) When you press the shutter button halfway, the shutter speed and aperture are set by the camera as with normal picture-taking without flash.

Mode	Shutter Speed Setting	Flash Aperture Setting
T_v (Shutter speed-priority AE)	Manual (30 sec. - 1/250 sec.)	Auto
A_v (Aperture-priority AE)	Auto (30 sec. - 1/250 sec.)	Manual
M (Manual)	Manual (30 sec. - 1/250 sec.)	Manual

- (2) When you press the shutter button completely, preflash evaluative metering based on the aperture set in (1) is used for the E-TTL autoflash exposure.
- (3) The background exposure is set by the shutter speed and aperture combination.

High-Speed Sync (FP Flash)

When the Speedlite 550EX is set to the high-speed sync mode (**FP**), it can synchronize at all shutter speeds, even those faster than 1/250 sec. When high-speed sync is enabled, **FP** is displayed in the viewfinder to indicate high-speed sync.

High-speed sync is effective in the following cases:

- (1) When you want to use fill flash for a portrait and maintain background blur with a large aperture.
- (2) When you want to produce a catchlight in the subject's eyes.
- (3) When you want to use fill flash to eliminate shadows



With conventional flash.



With FP flash.

FE Lock

FE (flash exposure) lock obtains and locks the correct flash exposure reading for any part of the scene.

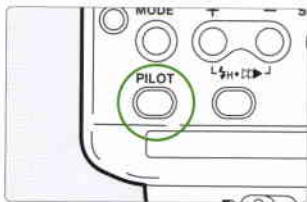

1 Check that the Speedlite's pilot lamp is lit.

- The flash mode can be either normal or high-speed sync. FE lock works with either mode.

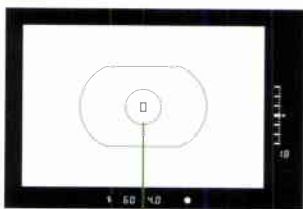

Spot metering circle

2 Focus the subject.

- Focus at the point where you want to lock the flash exposure.

3 Aim the spot metering circle over the part where you want to lock the flash exposure, then press the <FEL> button (Ø16).

- The Speedlite fires a preflash and stores the required flash output in memory.
- In the viewfinder, the focusing point achieving FE lock flashes in red.

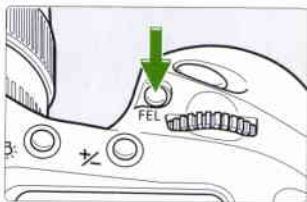



- Below the viewfinder, the display shown by ① appears for 0.5 sec. followed by the display shown by ②.



4 Compose the shot and take the picture.

For this picture, the flash exposure was locked for the face and then the picture was recomposed. The subject was exposed correctly without being affected by the background reflection.

- If the subject is too far away resulting in underexposure, the  icon will blink. Get closer to the subject and follow steps 3 and 4.

C.Fn C.Fn-13-1/3 enables FE lock with the manually-selected focusing point.
(→p.106)

Flash Exposure Compensation

With the camera, you can set the EOS-dedicated Speedlite's flash exposure compensation amount up to ± 3 stops in 1/3-stop increments.

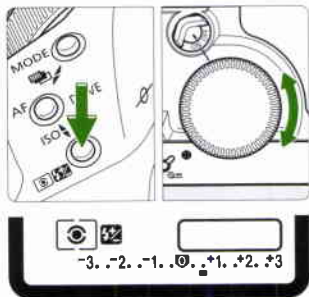

- 1** While pressing the $\langle \text{Fn} \rangle$ button, turn the $\langle \text{Mode} \rangle$ dial to set the desired flash exposure compensation amount.

- On the LCD panel, the plus side of the scale indicates overexposure and the minus side indicates underexposure. The sample display shows +2/3 stop flash exposure compensation.

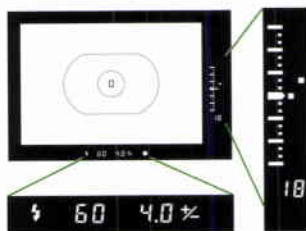

- 2** Take the picture.

- Press the shutter button halfway to display the flash exposure compensation amount on the viewfinder's exposure level scale.
- Press the $\langle \text{Fn} \rangle$ button to display the flash exposure compensation amount on the LCD panel.
- To cancel flash exposure compensation, set the flash exposure compensation amount to $\langle 0 \rangle$.

- !**
- The flash exposure compensation amount will be retained even after the $\langle \text{Fn} \rangle$ switch is set to $\langle \text{OFF} \rangle$.
 - The flash exposure compensation amount can also be set with Canon Speedlites 550EX, 540EZ, 430EZ, and Macro Ring Lite MR-14EX. If flash exposure compensation is set with both the camera and Speedlite, the Speedlite's flash exposure compensation amount will override the one set with the camera.

C.Fn C.Fn-6-2 enables the flash exposure compensation amount to be set in 1/2-stop increments. (\rightarrow p.102)

FEB (Flash Exposure Bracketing)

With the Canon Speedlite 550EX, three successive flash shots can be bracketed automatically up to ± 3 stops in 1/3-stop increments. The flash output is changed for the three shots while the background exposure remains the same.



Correct exposure (0). Underexposure ($-1/3$ stop). Overexposure ($+1/3$ stop).

- Flash exposure bracketing is set with the 550EX. For details, see the 550EX's Instructions booklet.
- The flash exposure bracketing amount set with the 550EX is indicated by the flash exposure level indicator in the camera's viewfinder.
- Make sure the Speedlite 550EX is ready before taking the next bracketed shot. Single-frame shooting () is recommended.

C.Fn C.Fn-6-2 enables the flash exposure bracketing amount to be set in 1/2-stop increments. (→p.102)

Modeling Flash

By firing a modeling flash, you can see the shadows and other flash lighting effects produced by one or more Speedlites.

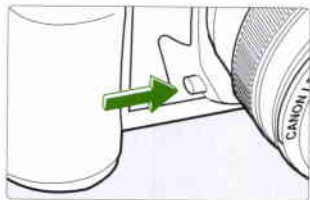

1 Make sure the camera and Speedlite are properly set for flash photography.

2 Press the camera's depth-of-field preview button.

- The Speedlite 550EX fires at 70 Hz for 1 second.

Wireless, Multi-Speedlite System

Speedlite 550EX has the following three features:

- (1) **E-TTL autoflash**
- (2) **Slave unit feature**
- (3) **Master unit feature for wireless control of 550EX slave units**

By using the above features, you can set up a wireless E-TTL autoflash system with multiple Speedlite 550EXs.

You can also set a flash output ratio for up to three groups of Speedlites to create the desired flash lighting effect.

- For details, see the 550EX and ST-E2's Instructions booklet.

Wireless, multi-Speedlite system

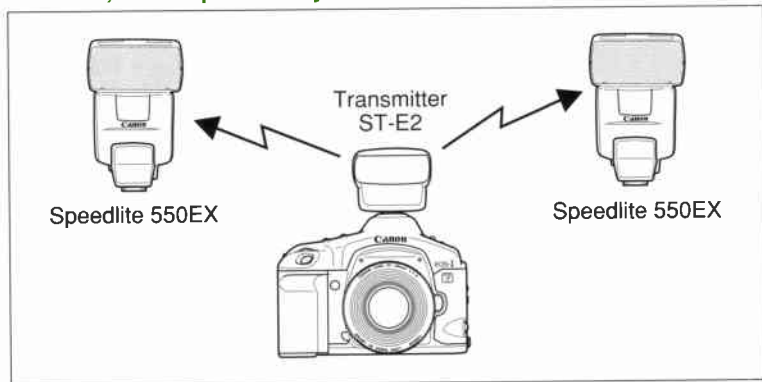

Using Other EOS-Dedicated Speedlites

With an EOS-dedicated Speedlite other than the EX series, TTL autoflash can be easily used like any AE mode.

The flash exposure is controlled by real-time, off-the-film flash metering linked to the focusing point.

- (1) When you press the shutter button halfway, the shutter speed and aperture are set automatically by the camera as with normal picture-taking without flash.

Mode	Shutter Speed Setting	Flash Aperture Setting
P (Program AE)	Auto (1/60 sec. - 1/250 sec.)	Auto
Tv (Shutter speed-priority AE)	Manual (30 sec. - 1/250 sec.)	Auto
Av (Aperture-priority AE)	Auto (30 sec. - 1/250 sec.)	Manual
M (Manual)	Manual (30 sec. - 1/250 sec.)	Manual

- (2) When you press the shutter button completely, TTL autoflash based on the aperture set in (1) is used.
- (3) The background exposure is set by the shutter speed and aperture combination.



- Flash exposure compensation can also be set with the camera.
- If the multi-Speedlite system is wired with flash cords, TTL autoflash takes effect.
- About automatic reduction of flash output

If an EOS-dedicated Speedlite is used to illuminate a subject backlit by an overhead light, the flash output is reduced automatically to avoid having an unnatural-looking exposure. This is called automatic reduction of flash output.

C.Fn C.Fn-14 can cancel the automatic reduction of flash output. (→p.107)

Using Non-Canon Flash Units

Sync Speed

The EOS-1 V can synchronize with compact, non-Canon flash units at 1/250 sec. or slower shutter speeds. With large studio flash, the sync speed is 1/125 sec. or slower. Be sure to test the flash to see if it synchronizes properly with the camera.

PC Terminal

The camera's PC terminal is provided for flash units using a sync cord. The PC terminal is threaded to prevent inadvertent disconnection. Only X-sync is used for synchronization at 1/250 sec. or slower.



- A flash unit attached to the camera's hot shoe and a flash unit connected to the PC terminal can be used at the same time.
- Canon EOS-dedicated Speedlites are recommended for use with this camera.



- If the camera is used with a flash unit or flash accessory dedicated to another camera brand, the camera may not operate properly and camera malfunction may result.
- There are studio flash units whose sync cord polarity is opposite from the camera's PC terminal. Such flash units do not work with the EOS-1V camera unless the polarity of the sync cable is changed. Consult the manufacturer of the flash unit or purchase a commercially-available polarity conversion cord. The camera's PC terminal polarity is shown in the figure on the right.

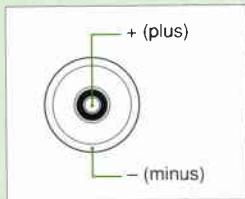

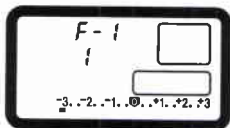

Custom Functions enable you to customize various camera features to suit your picture-taking preferences. In the previous text, the **C.Fn** symbol was used to point out relevant Custom Functions. In this chapter, all the Custom Functions are described in detail.

7

C.Fn-098	C.Fn-10 ...104
C.Fn-198	C.Fn-11 ...105
C.Fn-299	C.Fn-12 ...106
C.Fn-399	C.Fn-13 ...106
C.Fn-4 ...100	C.Fn-14 ...107
C.Fn-5 ...101	C.Fn-15 ...107
C.Fn-6 ...102	C.Fn-16 ...108
C.Fn-7 ...102	C.Fn-17 ...108
C.Fn-8 ...103	C.Fn-18 ...109
C.Fn-9 ...104	C.Fn-19 ...110

Custom Functions



First set the <🔊> switch to <ON>. If necessary, also set the <📷> switch to <ON>.

Selecting and Setting a Custom Functions

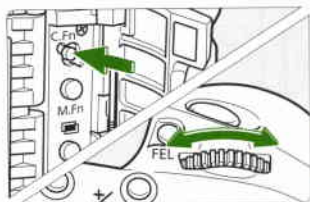

- 1 **Open the side door and press the <C.Fn> button.**
 - ▶ The Custom Function No. appears on the LCD panel.
- 2 **Turn the <Fn> dial until the desired Custom Function No. appears.**

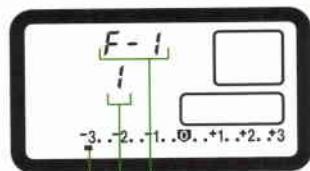

Custom Function No.
 Custom Function setting
 Altered Custom Function indicator on exposure compensation scale

- 3 **Press the <C.Fn> button to change the Custom Function's setting.**
 - ▶ The Custom Function setting changes each time you press the <C.Fn> button.
 - ▶ To change C.Fn-0's setting, press the <C.Fn> button for at least 2 seconds. (→p.127)
- 4 **Press the shutter button halfway.**
 - ▶ The LCD panel returns to the normal display and the new Custom Function setting takes effect.

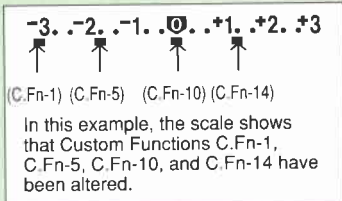

• **Altered Custom Function Indicator**
 After you alter a Custom Function setting and press the <C.Fn> button, a bar ■ appears on the exposure compensation scale.

The scale's increments from left to right are used to denote the 19 Custom Functions. The left-most increment (-3) is for C.Fn-1. The next increment to the right denotes the next Custom Function in numerical order up to C.Fn-19.

• "C.Fn" is the abbreviation for "Custom Function."

Canceling a Custom Function

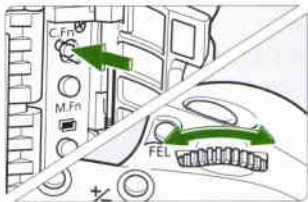

- 1** Open the side door and press the **<C.Fn> button**.
 - The Custom Function No. appears on the LCD panel.
- 2** Turn the **<FEL> dial** until the Custom Function No. whose setting is to be canceled appears.
- 3** Press the **<C.Fn> button** until the setting returns to **0**.

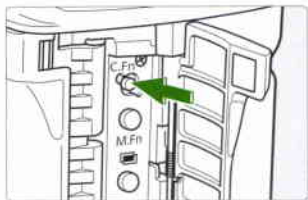

- 4** Press the shutter button halfway.
 - The LCD panel returns to the normal display and the Custom Function setting is canceled.

Canceling All Custom Functions

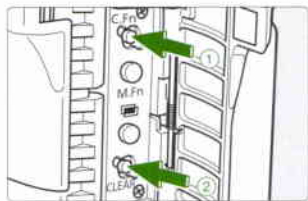



- Open the side door and press the <C.Fn> button. Then press the <CLEAR> button.**
- Except for C.Fn-0, all the Custom Function settings will be reset to 0.

Custom Function Settings

C.Fn-0 Focusing screen characteristics

This makes the camera's built-in exposure meter compatible with the focusing screen characteristics. Be sure to set this Custom Function to suit the focusing screen installed in the camera. (→p.127)

C.Fn	Function	No.		Description
C.Fn-0	Focusing screen characteristics	0		For Ec-N, Ec-R
		1		For Ec-A, B, C, CII, CIII, D, H, I, L



C.Fn-0-0: For New Laser-matte screens.

C.Fn-0-1: For Laser-matte screens.

Since the EOS-1V's standard focusing screen is the Ec-CIII, C.Fn-0-1 is already set upon factory shipment.

C.Fn-1 Auto film rewind mode

You can disable auto film rewind or make it silent.



C.Fn	Function	No.		Description	
C.Fn-1	Auto film rewind mode	0		Enabled	High-speed rewind
		1		Disabled	
		2		Enabled	Silent rewind
		3		Disabled	

C.Fn-1-1/3: Disables automatic film rewind. **This is effective when you do not want film rewind to start on its own and make a sudden disturbance.** Press the <  > button to rewind. (→p.28)

C.Fn-1-2: This makes the automatic film rewind more silent.

C.Fn-2 Film leader position

When the film rewind is completed, you can leave out the film leader.

C.Fn	Function	No.	Description
C.Fn-2	Film leader position	0	 Rewinds film leader into the cartridge.
		1	 Leaves film leader outside the cartridge.

C.Fn-2-1: **This is convenient if you develop your own film.**

 With C.Fn-2-1 set, the shutter speed will always be 1/8000 sec. when you release the shutter with the camera back open.

C.Fn-3 DX-coded film speed setting method

This can prevent the camera from automatically setting the ISO film speed.

C.Fn	Function	No.	Description
C.Fn-3	Automatic setting of DX-coded film speed	0	ISO DX Enabled
		1	ISO M Disabled

C.Fn-3-1: This enables you to set the film speed manually. (→p.73) **This ensures that the desired film speed is set.** You need not keep setting the film speed manually each time you load the film.

C.Fn-4 AF activation/AE lock

You can achieve focus and obtain the correct exposure separately. You can also stop the AI Servo AF operation temporarily.









C.Fn	Function	No.	Description
C.Fn-4	AF activation/ AE lock ● : Shutter button ● : AE lock button	0	●AF ●AEL Shutter button/AE lock button
		1	●AEL ●AEAF AE lock button/Shutter button
		2	●AF ●AFL Shutter button/Disabled (AF lock)
		3	●AE ●AEAF AE lock button/Disabled (→Real-time AE)

- C.Fn-4-1: **You can focus at one location and obtain AE lock at another location in the scene.** Press the <∗> button to autofocus and press the shutter button halfway to attain AE lock. (→p.71)
- C.Fn-4-2: In the AI Servo AF mode, **you can press the <∗> button to stop the AI Servo AF operation momentarily.** It prevents the AF from being thrown off by any passing obstruction coming between the camera and subject. The exposure is set when the picture is taken. (→p.36)
- C.Fn-4-3: **This is useful for subjects which keep moving and stopping repeatedly.** In the AI Servo AF mode, you can press the <∗> button to start or stop the AI Servo AF operation. The exposure is set when the picture is taken. Thus, the optimum focusing and exposure are always ready for the decisive moment.





 C.Fn-4 and C.Fn-19-0/1/2 (→p.110) both have AF start/stop and AE lock functions. If you have set both these Custom Functions and you execute both Custom Function operations, the latter operation will not work. The only exception will be when AF stop is executed after AF start.



C.Fn-5 Manual Tv/Av settings

During manual exposures, you can change the aperture with the <  > dial and set the aperture even while the lens is detached from the camera.

C.Fn	Function	No.		Description
C.Fn-5	Manual Tv/Av setting with the Main Dial / Quick Control Dial	0	 Tv  Av	Sets shutter speed/ Sets aperture
		1	 Av  Tv	Sets aperture/ Sets shutter speed
		2	 Tv  Av	Sets shutter speed/ Sets aperture
		3	 Av  Tv	Sets aperture/ Sets shutter speed

 This icon indicates that the aperture can be set with the lens detached from the camera.

- C.Fn-5-1: Use the <  > dial to set the shutter speed and the <  > dial to set the aperture. The shutter speed can also be set by pressing the <  > button and turning the <  > dial. **This is convenient when you have to often change the aperture during studio sessions with studio flash units.** (→p.66)
Also, when you use AEB in the manual exposure mode, the shutter speed can stay fixed while only the aperture is shifted for AEB.
- C.Fn-5-2: You set the shutter speed and aperture in the same way as with C.Fn-5-0. And you can still set the aperture even while the lens is detached from the camera. **Convenient especially for pro photographer assistants when a super telephoto lens is used with more than one EOS-1V body.**
- C.Fn-5-3: You set the shutter speed and aperture in the same way as with C.Fn-5-1. And you can still set the aperture even while the lens is detached from the camera.

 If this Custom Function is used with C.Fn-11-1/2, you have to use the <  > button and dial instead of the <  > button and dial to set the shutter speed and aperture.

C.Fn-6 Exposure level increments

You can change the increments for the exposure setting (shutter speed and aperture) and exposure compensation (AE, AEB, flash exposure).

C.Fn	Function	No.	Description
C.Fn-6	Increments for the exposure setting (shutter speed/aperture) and exposure compensation	0	1/3 STEP 1/3-stop exposure setting/ 1/3-stop exposure compensation
		1	1 STEP 1-stop exposure setting/ 1/3-stop exposure compensation
		2	1/2 STEP 1/2-stop exposure setting/ 1/2-stop exposure compensation

C.Fn-6-1: **Sets whole-stop increments for the shutter speed and aperture which might be familiar to older users.**

C.Fn-6-2: **Suited for negative films which have a relatively wide exposure latitude.**

C.Fn-7 USM lens electronic manual focusing

After focus is achieved in the One-Shot AF mode, **electronic manual focusing is possible** with the following lenses:

EF 50mm f/1.0L USM, EF 85mm f/1.2L USM, EF 200mm f/1.8L USM, EF 300mm f/2.8L USM, EF 400mm f/2.8L USM, EF 500mm f/4.5L USM, EF 600mm f/4L USM, EF 1200mm f/5.6L USM, EF 28-80mm f/2.8-4L USM.

C.Fn	Function	No.	Description
C.Fn-7	Electronic manual focusing after One-Shot AF	0	AF MF Enabled (With C.Fn-4-1/3, enabled before achieving focus)
		1	AF (M) Disabled (With C.Fn-4-1/3, enabled before achieving focus)
		2	AF Disabled (Disabled before achieving focus even with C.Fn-4-1/3)

C.Fn-7-1: This prevents the focus from being thrown off by inadvertent turning of the focusing ring after One-Shot AF. (Focusing is possible before focus is achieved.) With both C.Fn-7-1 and C.Fn-7-2, manual focusing is possible with the lens focus mode switch set to **MF** or **M**.

C.Fn-7-2: Electronic manual focusing is disabled in the AF mode.

 When both C.Fn-4 and C.Fn-7 are set, electronic manual focusing will be enabled or disabled as follows:

Custom Function No.	C.Fn-4		
	Setting	0, 2	1, 3
C.Fn-7	0	X / O	O / O
	1	X / X	O / X
	2	X / X	X / X



* Before focus is achieved/After focus is achieved

O: Enabled

X: Disabled

C.Fn-8 Frame counter sequence

The frame counter can count down to show the remaining number of frames, or it can be displayed in the viewfinder in the same way as with the EOS-1N.

C.Fn	Function	No.	Description
C.Fn-8	Frame counter sequence	0	 Counts up
		1	 Counts down
		2	 F or 9 - 0 displayed by frame counter in viewfinder (same as with EOS-1N).





C.Fn-8-1: You can see how many frames are left in the roll. The frame counter in the viewfinder also counts down. The  icon will be displayed on the left of the frame counter on the LCD panel and in the viewfinder.

C.Fn-8-2: The frame counter in the viewfinder will be displayed in the same way as with the EOS-1N. When the remaining number of frames is 10 or more, "F" is displayed. When it is 9 or less, a count down is displayed.

C.Fn-9 AEB sequence and auto cancellation

You can alter the standard AEB sequence of correct exposure, underexposure, and overexposure and prevent AEB cancellation after changing the lens, reloading film, or turning off the Main Switch.

O: Correct exposure - : Underexposure + : Overexposure

C.Fn	Function	No.	Description
C.Fn-9	AEB sequence/Auto cancellation after lens change, film loading, or Main Switch OFF	0	 O, -, + / Enabled
		1	 O, -, + / Disabled
		2	 -, O, + / Enabled
		3	 -, O, + / Disabled





C.Fn-9-1: **You can continue taking AEB shots in this sequence.**

C.Fn-9-2: **The AEB sequence progresses from the shortest exposure.**

C.Fn-9-3: **You can continue taking AEB shots in the same sequence as with C.Fn-9-2.**

C.Fn-10 Focusing point flashing mode

You can disable the in-focus flashing of the focusing point or make it brighter for easier visibility in bright scenes.



C.Fn	Function	No.	Description
C.Fn-10	Focusing point flashing mode	0	 Enabled
		1	 Disabled
		2	 Enabled (No dim flashing)
		3	 Bright flashing















C.Fn-10-1: The focusing point does not flash at all.





C.Fn-10-2: **Prevents the dimmed flashing of C.Fn-10-0.**

C.Fn-10-3: **Effective when the focusing point flashing is difficult to see with C.Fn-10-0.**



C.Fn-11 Focusing point selection method

This converts the <  > button or < FEL > button into the <  > button. You can thereby position the focusing point selector according to your personal preference. The <  > dial can also be used to select a horizontal or vertical focusing point.

C.Fn	Function	No.	Description
C.Fn-11	Focusing point selection method	0	 ↔ <  > + <  >
			↕ <  > + <  >
		1	↔ <  > + <  >
			↕ <  > + <  >
		2	↔ <  > Stand-alone operation
			↕ <  > + <  >
		3	↔ < FEL > + <  >
			↕ < FEL > + <  >

C.Fn-11-1: This reverses the functions of the <  > button and <  > button. Press the <  > button, then turn the <  > dial to select a horizontal focusing point or turn the <  > dial to select a vertical focusing point.



C.Fn-11-2: While exposure metering is active, turn the <  > dial to select a horizontal (or peripheral focusing point with C.Fn-13-3 set) focusing point. This is also possible while you press the shutter button halfway during AI Servo AF.

To select a vertical focusing point, hold down the <  > button and turn the <  > dial. (If C.Fn-18-1/2 has been set, a vertical focusing point cannot be selected in this way.)



Turning the dial beyond the peripheral focusing point will not select any other focusing point.

C.Fn-11-1 operations are also possible.

Pressing the <  > button during autofocus will switch to the automatic focusing point selection mode.

C.Fn-11-3: This reverses the functions of the <  > button and < FEL > button. Press the < FEL > button, then turn the <  > dial to select a horizontal focusing point or turn the <  > dial to select a vertical focusing point.





C.Fn-12 Mirror lockup

C.Fn	Function	No.	Description
C.Fn-12	Mirror lockup	0	 Disabled
		1	 Enabled

C.Fn-12-1: Effective for close-up and telephoto shots to prevent camera vibration caused by the mirror's reflex action. See page 81 to use this feature.

C.Fn-13 Focusing point selection limit and spot metering linkage

The selectable focusing points can be limited to 11 or 9 to make focusing point selection faster. Spot metering can also be linked to the focusing point. This makes it easier to frame the subject, and it is effective for spotlighted subjects.

C.Fn	Function	No.	Description
C.Fn-13	Focusing point selection limit / Spot metering linkage (FE lock)	0	 45 / Center focusing point
		1	 11 / Active focusing point
		2	 11 / Center focusing point
		3	 9 / Active focusing point

C.Fn-13-1: The selectable focusing points are limited to 11. Spot metering is linked to the active focusing point. (→p.38)

C.Fn-13-2: The selectable focusing points are limited to 11. Spot metering is linked to the center focusing point. (→p.38)



C.Fn-13-3: The selectable focusing points are limited to 9. Spot metering is linked to the active focusing point. (→p.38)

-  • The metering mode must be set to spot metering before it can be linked to the focusing point.
- If C.Fn-13-1/2 is set or cancelled, the registered focusing point (→p.42) will be replaced by the center focusing point.





- Any metering mode besides spot metering can be used.
- With C.Fn-13-1/2/3, all 45 focusing points will be subject to automatic selection.

C.Fn-14 Automatic reduction of fill flash output

C.Fn	Function	No.	Description
C.Fn-14	Automatic reduction of fill flash output	0	 Enabled
		1	 Disabled

C.Fn-14-1: **This prevents underexposure of a subject in front of a strong backlight such as a sunset.**

C.Fn-15 Shutter curtain synchronization

C.Fn	Function	No.	Description
C.Fn-15	Shutter curtain synchronization	0	 1st-curtain synchronization
		1	 2nd-curtain synchronization

C.Fn-15-1: **By using a slow sync speed, you can create a light trail following a moving subject.** The flash fires right before the shutter closes.

This Custom Function can be used to obtain 2nd-curtain sync effects even with EX-series Speedlites which do not have this capability. If an EX-series Speedlite having this capability is set for 2nd-curtain sync, it will override the camera's setting.

C.Fn-16 Safety shift

Safety shift can be set for the shutter speed-priority AE and aperture-priority AE modes.



C.Fn	Function	No.	Description
C.Fn-16	Safety shift for Tv-AE and Av-AE	0	 Disabled
		1	 Enabled

C.Fn-16-1: In case the subject's brightness changes suddenly and the current shutter speed-priority AE or aperture-priority AE setting becomes unsuitable, the shutter speed or aperture is shifted to obtain a suitable exposure.

C.Fn-17 Focusing point activation area

The manually selected focusing point's activation area can be expanded. (→p.44)

Setting C.Fn-13 will also expand the focusing point activation area.

C.Fn	Function	No.	Description
C.Fn-17	Focusing point activation area	0	 1 (Standard)
		1	 1 + Adjacent focusing points
		2	 1 + More adjacent focusing points

C.Fn-17-1: The focusing point activation area expands by one point all around the manually-selected focusing point. A total of 7 focusing points become active. This setting is effective for when only one manually-selected focusing point is unable to focus track a subject moving irregularly.

C.Fn-17-2: The camera automatically sets the focusing point activation area to 1, 7 or 13 points to suit the lens focal length, AF mode, and the subject's speed during predictive AF. (→p.44) This is effective when the subject's movement is unpredictable.



The focusing point activation area centers on the selected focusing point. Therefore, if a peripheral focusing point is selected, the focusing point activation area will be smaller as shown below.

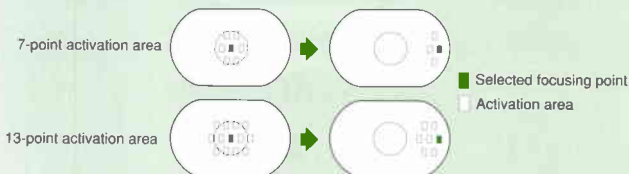

C.Fn-18 Switchover to registered focusing point

You can switch to the registered focusing point just by pressing the $\langle \text{Fn} \rangle$ button. (→p.42)

C.Fn	Function	No.	Description
C.Fn-18	Switchover to registered focusing point	0	Use $\langle \text{Fn} \rangle$ button + $\langle \text{Fn} \rangle$ button
		1	Use only $\langle \text{Fn} \rangle$ button
		2	Switchover only while pressing $\langle \text{Fn} \rangle$ button

C.Fn-18-1: Press the $\langle \text{Fn} \rangle$ to switch to the registered focusing point.

C.Fn-18-2: Switch to the registered focusing point only while you press the $\langle \text{Fn} \rangle$ button. When you release the button, it switches back to the previous focusing point. **You can thereby easily switch between the selected focusing point and registered focusing point.**



If C.Fn-4-1/3 is also set, you can press the $\langle \text{Fn} \rangle$ button to switch to the registered focusing point and start the AF at the same time. (→p.100)

C.Fn-19 Lens AF stop button function switching

The function of the AF stop button provided with super telephoto Image Stabilizer lenses can be shifted to the AF start button or AE lock button.

C.Fn	Function	No.	Description
C.Fn-19	Lens AF stop button function switching	0	AFL AF stop
		1	AF AF start
		2	AEL AE lock while metering is active
		3	 Automatic selection of 45 focusing points when pressed
		4	AF MODE Toggle between One-Shot AF and AI Servo AF
		5	IS Turn on Image Stabilizer

C.Fn-19-1: **AF operates only while the AF stop button is pressed.** While the button is pressed, AF operation with the camera is disabled.

C.Fn-19-2: When the button is pressed while metering is still active, AE lock takes effect. **Convenient when you want to focus and meter separately.**

C.Fn-19-3: **One of the 45 focusing points is selected automatically only while you press the button.** It switches from manual focusing point selection to automatic focusing point selection. Convenient when you are no longer able to focus track a moving subject with a manually-selected focusing point in the AI Servo AF mode.

C.Fn-19-4: In the One-Shot AF mode, pressing the button switches to AI Servo AF mode only while the button is pressed. In the AI Servo AF mode, pressing the button switches to One-Shot AF mode only while the button is pressed. **Convenient when you need to keep switching between One-Shot AF and AI Servo AF for a subject which keeps moving and stopping.**

C.Fn-19-5: With the lens' IS switch already ON, **the Image Stabilizer operates only while you press the button.**

Personal Functions

Personal Functions enable you to further customize your camera settings. They are set with EOS LINK SOFTWARE ES-E1 (sold separately, →p.130) which connects the EOS-1V to a personal computer.

P.Fn-0 (Custom Function group registration) can be set with the EOS-1V body as well.

Personal Functions

P.Fn-0	Custom Function group registration.
P.Fn-1	Disables unwanted picture-taking mode(s).
P.Fn-2	Disables unwanted metering mode(s).
P.Fn-3	Specifies the metering mode for manual exposure.
P.Fn-4	Sets the maximum and minimum shutter speeds to be used.
P.Fn-5	Sets the maximum and minimum apertures to be used.
P.Fn-6	Registers and switches the shooting mode and metering mode.
P.Fn-7	Repeats AEB during continuous shooting.
P.Fn-8	Sets AEB only for the first two frames.
P.Fn-9	Changes the AEB sequence for C.Fn-9-2/3 to overexposure, correct exposure, and underexposure.
P.Fn-10	Maintains the shift amount for program shift.
P.Fn-11	Prevents cancellation of multiple exposures.
P.Fn-12	Sets the AI Servo AF's subject-tracking sensitivity.
P.Fn-13	AI Servo AF continuous shooting is executed according to the film advance speed.
P.Fn-14	Disables AF lens driving for focus search.
P.Fn-15	Disables the AF-assist beam from being emitted.
P.Fn-16	Enables the picture to be taken automatically when focus is achieved at the fixed point of focus while the shutter button is pressed completely.
P.Fn-17	Prevents automatic focusing point selection from being set.
P.Fn-18	Enables automatic focusing point selection when C.Fn-11-2 has been set.
P.Fn-19	Sets the film advance mode's continuous shooting speed for when the Power Drive Booster is attached.
P.Fn-20	Limits the number of frames exposed during continuous shooting.
P.Fn-21	Enables silent (low-speed) film advance when the shutter button is OFF after picture-taking.
P.Fn-22	Disables the shutter release when film has not been loaded.
P.Fn-23	The function activation timer after the button is pressed can be changed to a different time length (0.6, 0.16, etc.).
P.Fn-24	Prevents the LCD panel illumination from turning off during bulb exposures.
P.Fn-25	Changes the default settings implemented when the CLEAR button is ON.
P.Fn-26	Shortens the shutter release time lag.
P.Fn-27	Enables the electronic dial's function to be used in the reverse direction.
P.Fn-28	Prevents exposure compensation with the Quick Control Dial.
P.Fn-29	Issues a warning when there is enough memory to store shooting data for only a few more rolls of film.
P.Fn-30	Changes the imprinting density of the film ID.

P.Fn-0 Custom Function Group

To suit various shooting situations such as sports, snapshots, and landscapes, up to three different sets of Custom Function settings can be registered with the "Personal Function 0" setting.

Custom Function Group Registration

1 Set all the preferred Custom Function settings. (→p.96)

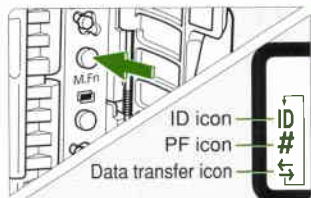

2 Press the <M.Fn> button to set the Personal Function mode.

- Each time you press the button, one of the three icons on the left side of the LCD panel will appear in turn. Press the button until the PF icon # appears.

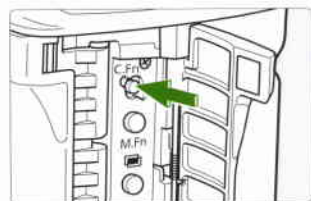

3 Press the <C.Fn> button to set the Custom Function group number.

- Each time the button is pressed, the Custom Function group number changes in the following looping sequence: 0, 1, 2, 3, 0. An unregistered group number will blink while a registered group number will not blink.
- Select only 1, 2, or 3. "0" cannot be selected.

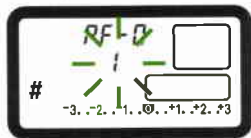
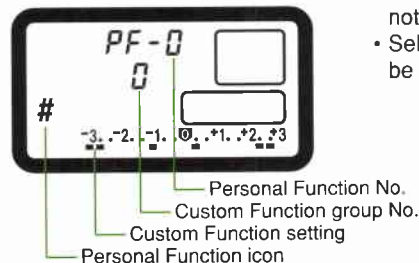

 "PF-0-0" indicates the current setting.

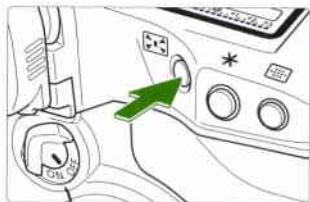

4 Press the button to register the Custom Function settings as a group.

- C.Fn-1 to C.Fn-19 will be registered as one set of Custom Function settings.

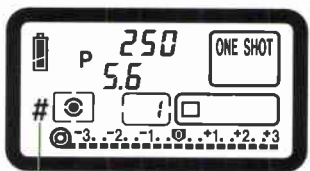
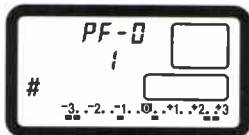

PF icon

5 Press the shutter button halfway.

- The LCD panel returns to the normal display and this completes the Custom Function group registration. When the registered Custom Function group is being used, the # icon is displayed on the LCD panel.
- To register a Custom Function group for PF-0-2 and PF-0-3, repeat steps 1 to 5. The procedure must be repeated if any of the Custom Function settings have been changed.

 C.Fn-0 (Focusing screen characteristics) is not registered in the Custom Function group.

Selecting a Custom Function Group

To select a Custom Function group, follow steps 2 and 3 to select the Custom Function group No., then press the shutter button halfway. This selects the Custom Function group to be used.

 The Custom Functions in a registered group cannot be cancelled all at one time. (→p.97)

 "P.Fn" is the abbreviation for "Personal Function."

Recording the Shooting Data

The EOS-1V can record the shooting data automatically. The recorded data can be viewed and edited with a personal computer by using EOS LINK SOFTWARE ES-E1 (sold separately).

Standard Shooting Data

1. Selectable No.
2. Film ID
3. Film-loaded date and time
4. DX-coded film speed
5. Frame No.
6. Shooting mode
7. Lens max. aperture
8. Shutter speed used
9. Battery-loaded date and time
10. Manually set ISO speed
11. Exposure compensation amount
12. Flash exposure compensation amount
13. Flash mode
14. Metering mode
15. Lens focal length used
16. Film advance mode
17. AF mode

Optional Shooting Data Recordable with EOS LINK SOFTWARE ES-E1

1. Bulb exposure time
2. Date
3. Time
4. Custom Function settings
5. Focusing point selection
6. Multiple exposures
7. Focusing points achieving focus
8. Battery loaded date and time

The EOS-1V HS attached with Power Drive Booster PB-E2 offers four film advance modes. The vertical grip also has its own shutter button, focusing point selector <☐>, Main Dial <☀>, FE lock/multi-spot metering button <FEL>, and AE lock button <✳>. The camera is powered by eight size-AA batteries. The Nickel-Hydride Pack NP-E2 and the dedicated Nickel-Hydride Charger NC-E2 (both sold separately) are also available. For better holding comfort, Handstrap E1 is also available.

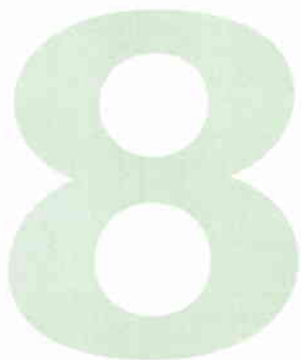

For EOS-1V HS Users



First set the <☉> switch to <ON>.

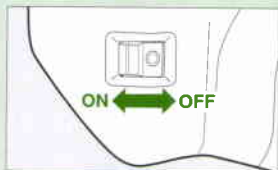

To use the vertical-grip controls, first set the PB-E2's ON/OFF switch to ON.

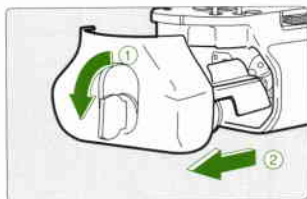
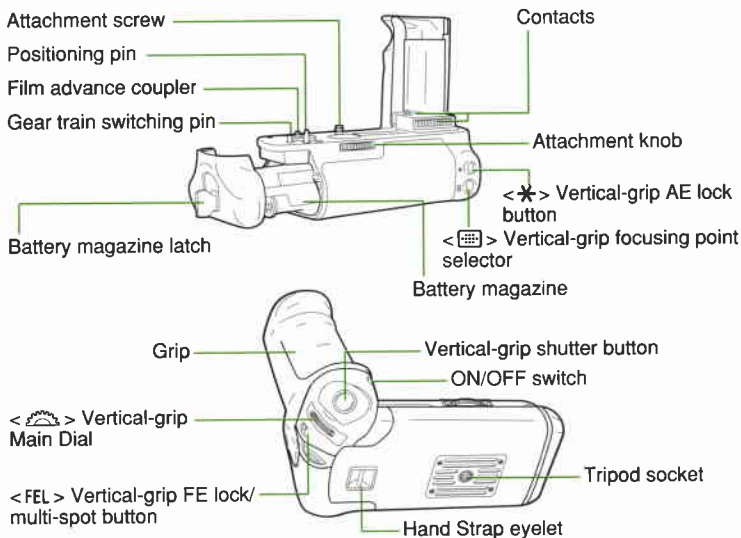

1 Remove the battery magazine.

- Turn the battery magazine latch as shown by the arrow. Then pull out the magazine.
- To reinstall the battery magazine, follow this procedure in reverse.

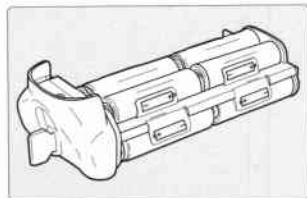

2 Install the batteries.

- Refer to the battery orientation diagram on the magazine and install the batteries in the proper + and - orientation. If any battery is not oriented properly, the Power Drive Booster will not operate.
- The battery level can be checked with the camera. (→p.24)

Film Advance Modes (→p.77)

• < > Ultra-high speed continuous shooting

With the Nickel-Hydride Pack NP-E2 attached (sold separately →p.133), shoot up to about 10 frames per sec. while pressing the shutter button.

• < > High-speed continuous shooting

Shoot up to about 6 frames per sec. (or 7 fps with NP-E2) while pressing the shutter button.



• < > Low-speed continuous shooting

Shoot up to about 3 frames per sec. while pressing the shutter button.

• < > Single-frame shooting

After a picture is taken, the film advances by 1 frame automatically.

Continuous Shooting Speed According to AF Mode and Battery Type In fps (approx.)

Mode	One-Shot AF / Manual		AI Servo AF	
	NP-E2	Size-AA batteries	NP-E2	Size-AA batteries
<  > Ultra-high speed continuous shooting	10	—	9	—
<  > High-speed continuous shooting	7	6	7*	5
<  > Low-speed continuous shooting	3	3	3	3

- The figures above apply when the shutter speed is 1/250 sec. or faster.

EOS-1V HS Film Roll Shooting Capacity

Power Source Temperature	AA Alkaline	AA Lithium	AA Ni-Cd	Nickel-Hydride Pack NP-E2
At 20°C	125 (85)	180 (120)	50 (35)	100 (70)
At -20°C	7 (5)	75 (50)	36 (24)	30 (20)

- The figures in the table above indicate the number of 24-exposure rolls that can be shot with a new set of batteries and an EF 50mm f/1.4 lens in accordance with Canon's testing conditions. Figures in parentheses indicate the number of 36-exposure rolls.
- The shooting capacity will be less if test shooting or autofocus without film is performed.
- Size-AA nickel-hydride batteries can also be used.

Attaching Grip GR-E2

You can replace the Power Drive Booster PB-E2 with the normal Grip GR-E2 (sold separately) found on the EOS-1V. The GR-E2 uses one lithium 2CR5 battery.

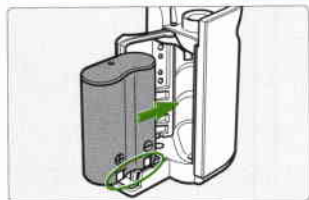

1 Install a battery in the Grip GR-E2. (→p.19)

- As shown in the diagram, insert the battery with the contacts toward the bottom right. Then close the cover.

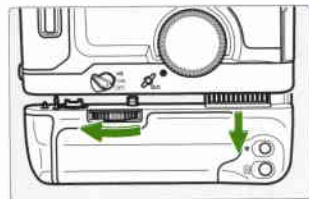

2 Detach the Power Drive Booster PB-E2.

- Turn the Power Drive Booster PB-E2's attachment knob as shown by the arrow to loosen it. Then slide down the Booster.
- On the bottom of the EOS-1V, attach the cover (provided with the GR-E2) on the film advance coupler. (→p.8)

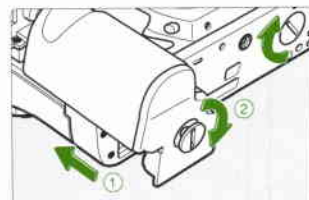

3 Attach the Grip GR-E2.

- Attach the Grip to the camera and tighten the Grip's attachment screw.
- Attach the contact cover (provided with the GR-E2) to the Power Drive Booster PB-E2 to protect the electrical contacts.

⚠ Cautions when using the Power Drive Booster PB-E2 with the EOS-1 and EOS-1N

- Do not use size-AA lithium FR6 batteries or the Nickel-Hydride Pack NP-E2 with the EOS-1. Doing so may damage the EOS-1's electronic circuitry due to the high battery voltage.
- Do not use the Nickel-Hydride Pack NP-E2 with the EOS-1N. If the battery voltage gets really low, battery pack performance may deteriorate markedly.

This section helps you understand your camera and enjoy photography better. It gives reference information for your camera and introduces system accessories.



Reference Section

Basic Photography Terms

Exposure

Exposure occurs when the film is exposed to light. Correct exposure is obtained when the film is exposed to a proper amount of light in accordance with the film's sensitivity to light. The correct exposure is adjusted with the camera's shutter speed and aperture.

Shutter speed

The shutter speed is the length of time the camera's shutter opens to expose the film to the light coming through the lens. The shutter speed is displayed on the camera's LCD panel and in the viewfinder. It ranges from 30 to 1/8000 sec. and bulb.

Aperture

The aperture setting (f-number) indicates the size of the aperture opening in the lens. It is used to adjust the amount of light striking the film.

The aperture setting is displayed on the camera's LCD panel and in the viewfinder. It can range anywhere from 1.0 to 91, depending on the lens attached to the camera.



ISO film speed

The ISO film speed indicates the film's sensitivity to light. The higher the film speed, the more sensitive the film is. Therefore, ISO 400 and higher-speed films are suited for low-light conditions. The ISO film speed is set in accordance with standards set by the International Standardization Organization (ISO).

A film speed from 6 to 6400 can be set with the camera. The film speed is displayed on the LCD panel and in the viewfinder.

Depth of field

This is the range where acceptable focus can be achieved in front of and behind the point of optimum focus. The smaller the aperture (the larger the f-number), the deeper the depth of field. And the larger the aperture (the smaller the f-number), the shallower the depth of field.

The depth of field is affected as described below:

- (1) A smaller aperture (a larger f-number) increases the depth of field.
For example, stopping down to $f/8$ obtains a greater depth of field than $f/4.5$.
- (2) A lens with a shorter focal length increases the depth of field.
A wide-angle lens obtains a deeper depth of field than a telephoto lens.
- (3) A longer distance between the camera and subject increases the depth of field.
- (4) The depth of field behind the point of optimum focus is longer than the depth of field in front of the point of optimum focus.

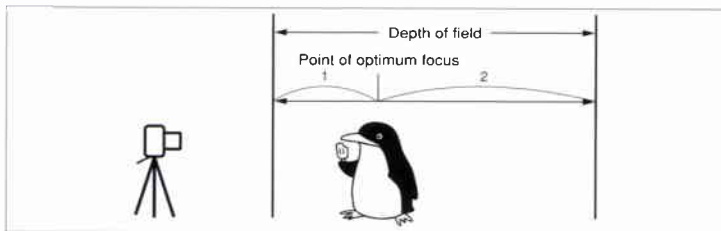











Aperture set to $f/2$.



Aperture set to $f/22$.









Troubleshooting Guide

If there is a problem, first refer to this Troubleshooting Guide. If the problem still persists, take the camera to your nearest Canon Service Center. Canon Service Centers are listed on the back of this booklet.

<p>Nothing is displayed on the LCD panel.</p>	<p><  > is <OFF>.</p> <ul style="list-style-type: none">▶ Set the <  > switch to <ON>. (→p.14) <p>The battery is exhausted.</p> <ul style="list-style-type: none">▶ Replace the battery with a new one. (→p.19, 20) <p>The battery has been installed incorrectly.</p> <ul style="list-style-type: none">▶ Install the battery correctly. (→p.19)
<p>The camera's Custom Function cannot be set.</p>	<p><  > is <OFF>.</p> <ul style="list-style-type: none">▶ Set the <  > switch to <ON>. (→p.14) <p>The <  > switch is <OFF>.</p> <ul style="list-style-type: none">▶ Set the <  > switch to <ON>. (→p.17)
<p>AF does not work when the shutter button is pressed halfway.</p>	<p><  > is <OFF>.</p> <ul style="list-style-type: none">▶ Set the <  > switch to <ON>. (→p.14) <p>The lens focus mode is set to MF (or M).</p> <ul style="list-style-type: none">▶ Set the lens focus mode to AF (or A). (→p.21) <p>C.Fn-4 is set to 1 or 3.</p> <ul style="list-style-type: none">▶ Set C.Fn-4 to 0. (→p.100)
<p>The shutter does not work.</p>	<p>The <  > icon blinks on the LCD panel.</p> <ul style="list-style-type: none">▶ Take out the film and load it correctly. (→p.25, 26) <p>The <  > icon blinks on the LCD panel.</p> <ul style="list-style-type: none">▶ Replace the battery. (→p.19) <p>The <  > icon blinks while the rewind film is still in the camera.</p> <ul style="list-style-type: none">▶ Replace with a new roll of film. (→p.28, 25) <p>The in-focus indicator in the viewfinder blinks and focus cannot be achieved.</p> <ul style="list-style-type: none">▶ Select another focusing point. (→p.38) If focus still cannot be achieved, focus manually. (→p.48)

<p>The film does not rewind automatically.</p>	<p>The temperature is cold, and it has suddenly affected the battery level.</p> <ul style="list-style-type: none"> ▸ Replace with a new battery. (→p.19) Keep a spare battery on hand and warm the battery in your pocket alternately. (→p.7) <p>C.Fn-1 is set to 1 or 3.</p> <ul style="list-style-type: none"> ▸ Set C.Fn-1 to 0 or 2. (→p.98)
<p>The <⏪> icon blinks on the LCD panel.</p>	<p>The battery level is very low.</p> <ul style="list-style-type: none"> ▸ Replace the battery with a new one. (→p.19) <p>A misoperation has occurred with the camera, lens, or Power Drive Booster.</p> <ul style="list-style-type: none"> ▸ Remove and reload the battery. (→p.19, 116) If the <⏪> icon stops blinking, picture-taking is possible. If it is still blinking, consult your nearest Canon Service Center.

Exposure Warning List

Mode	Blinking Warning	Indication	Countermeasures
P		The subject is too dark.	Use flash.
		The subject is too bright.	Attach a neutral density filter to the lens.
Tv	125 	The picture will be underexposed.	Turn the to set a slower shutter speed.
	125 	The picture will be overexposed.	Turn the to set a faster shutter speed.
Av		The picture will be underexposed.	Turn the to set a larger aperture (smaller f-number).
		The picture will be overexposed.	Turn the to set a smaller aperture (larger f-number).
DEP	60 	The desired depth of field cannot be obtained.	1) Move away from the subject and try again. 2) If a zoom lens is used, use the shortest focal length.
		The subject is too dark.	Use flash.
		The subject is too bright.	Attach a neutral density (ND) filter to the lens.

 The sample warnings apply when a lens having a maximum aperture of f/1.4 and minimum aperture of f/22 is attached to the camera. The maximum and minimum aperture warning displays will differ depending on the lens attached to the camera.

Program Line

The program line below applies when the camera is used in the Program AE <P> mode with an EF 50mm f/1.4 USM lens.

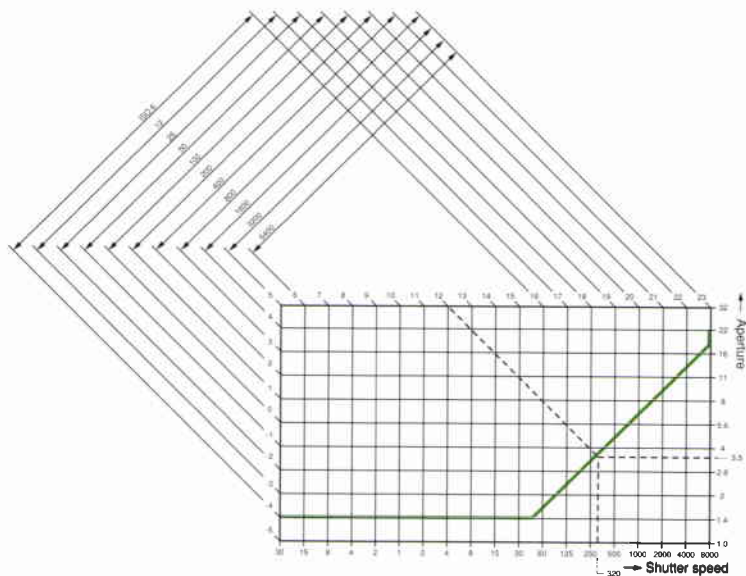

Program Line Description

The bottom horizontal axis represents the shutter speed and the right vertical axis represents the aperture. On the left edge and top edge of the graph, the Exposure Value (EV) is indicated for respective shutter speed and aperture combination set by the Program AE mode and denoted by the colored program line.

Example: When the subject brightness is EV 12, the point where the diagonal line from EV 12 (on the top edge of the graph) intersects the program line indicates the corresponding shutter speed (1/320 sec.) and aperture (f/3.5) which the program sets automatically.

The arrowhead lines above the graph indicate the metering range for the respective film speed.

Shutter Speed and Aperture Readouts

Shutter speed readout

The shutter speed is normally displayed in 1/3-stop increments. Numbers from "4" to "8000" denote the denominator of the shutter speed fraction. For example, "125" is 1/125 sec. Also, 0.3 is 0.3 sec., and 15" is 15 sec.

Aperture readout

The aperture is normally displayed in 1/3-stop increments. The larger the number, the smaller the aperture opening. The range of aperture numbers (f-numbers) displayed depends on the lens used.

1/3-stop Increments			1/2-stop Increments			Full-stop Increments		
Shutter speed	Aperture		Shutter speed	Aperture		Shutter speed	Aperture	
8000	13	1.0	25	8000	1"	1.0	8000	1.0
6400	10	1.1	29	6000	1.15	1.2	4000	1.4
5000	8	1.2	32	4000	2"	1.4	2000	2.0
4000	6	1.4	36	3000	3"	1.8	1000	2.8
3200	5	1.6	40	2000	4"	2.0	500	4.0
2500	4	1.8	45	1500	5"	2.5	250	5.6
2000	0.3	2.0	5.1	1000	8"	2.8	125	8.0
1600	0.4	2.2	5.7	750	10"	3.5	60	1.1
1250	0.5	2.5	6.4	500	15"	4.0	30	1.6
1000	0.6	2.8	7.2	350	20"	4.5	15	2.2
800	0.8	3.2	8.1	250	30"	5.6	8	3.2
640	1"	3.5	9.1	180		6.7	4	4.5
500	1.3	4.0		125		8.0	0.5	6.4
400	1.6	4.5		90		9.5	1"	9.1
320	2"	5.0		60		1.1	2"	
250	2.5	5.6		45		1.3	4"	
200	3.2	6.3		30		1.6	8"	
160	4"	7.1		20		1.9	15"	
125	5"	8.0		15		2.2	30"	
100	6"	9.0		10		2.7		
80	8"	1.0		8		3.2		
60	10"	1.1		6		3.8		
50	13"	1.3		4		4.5		
40	15"	1.4		0.3		5.4		
30	20"	1.6		0.5		6.4		
25	25"	1.8		0.7		7.6		
20	30"	2.0				9.1		
15		2.2						

C.Fn C.Fn-6 enables the shutter speed and aperture to be set in full-stop or 1/2-stop increments. (→p.102)

Interchanging the Focusing Screen

You can interchange the camera's focusing screen to suit the picture-taking application. You must also set C.Fn-0 so that the criteria for the correct exposure suits the focusing screen.

Focusing Screen Type	Designation	C.Fn-0 Setting
N : New Laser-matte Screen	Ec-N, Ec-R	0
L : Laser-matte Screen	Ec-series (A, B, C, CII, CIII, D, H, I, L)	1

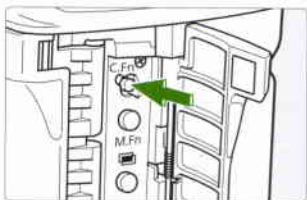

- 1 Open the side door and press the <C.Fn> button.**
 - The Custom Function No. appears.
- 2 Turn the <DIAL> dial until "F-D" appears.**
- 3 Press the <C.Fn> button for 2 seconds.**
 - Either "D" or "I" will be displayed on the LCD panel.
 - Pressing the <C.Fn> button toggles between D and I.
- 4 Press the shutter button halfway.**
 - The LCD panel's normal display reappears.

 C.Fn-0 cannot be registered in a Custom Function group.

- 
- If you do not replace the focusing screen that came with the camera, you need not change C.Fn-0's setting.
 - To change the focusing screen, refer to the Instructions that came with the focusing screen.
 - The Ec-A, Ec-B, Ec-I, and Ec-L focusing screens have a prism at the center. A correct exposure reading cannot be obtained with evaluative metering or spot metering based on the prism at the center. Use centerweighted averaging metering or off-center spot metering with these focusing screens.

Ec-series Interchangeable Focusing Screens

Ec-A: Standard microprism

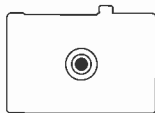

Compatible with all EF lenses. Lenses with a maximum aperture smaller than $f/5.6$ will cause the focusing screen's microprism to darken.

Ec-H: Laser-matte with scale

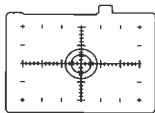

Compatible with all EF lenses. The scales at the center and periphery help you compose shots for close-ups and photomicrography.

Ec-B: New split screen



Compatible with all EF lenses. With slow lenses whose maximum aperture is smaller than $f/5.6$, the split-image circle may darken.

Ec-I: Laser-matte with cross hair reticle

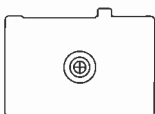

Use the cross hair at the center to focus. Suited for photomicrography and astrophotography.

Ec-CII: All Laser-matte

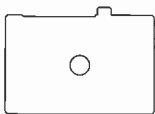

EOS-1N's standard focusing screen.

Ec-L: Cross split screen



Compatible with all EF lenses. Focus with the vertical and horizontal splits. Lenses with a maximum aperture smaller than $f/5.6$ will cause the focusing screen's split portion to darken.

Ec-CIII: Laser-matte

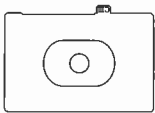

EOS-1 V's standard focusing screen. The CIII logo is imprinted on the lug to distinguish it from the Ec-N.

Ec-N: New Laser-matte

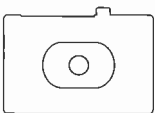

EOS-3's standard focusing screen.

Ec-D: Laser-matte with grid

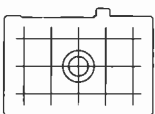

Compatible with all EF lenses. Ideal for architectural photography and photo duplication work.

Ec-R: New Laser-matte

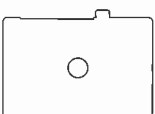

EOS-1N RS's standard focusing screen.

Major Accessories



- **Power Drive Booster PB-E2**

Together with the Ni-MH Pack NP-E2, Power Drive Booster PB-E2 enables a top continuous shooting speed of about 10 fps. The vertical grip has its own shutter button, Main Dial, AE lock button, FE lock button, and focusing point selector. It makes vertical shots as easy as horizontal shots. When equipped with Battery Magazine BM-E2, Power Drive Booster PB-E2 is also compatible with the EOS-1N and EOS-1.



- **Ni-MH Pack NP-E2**

This powerful battery pack is dedicated to Power Drive Booster PB-E2. The rated voltage is 12 V. It can deliver over 500 charging cycles. When fully charged, it has enough power for you to go through 70 rolls of 36-exposure film at 20 C.

* Power Drive Booster PB-E2 installed with this Pack cannot be used with the EOS-1N and EOS-1.



- **Ni-MH Charger NC-E2**

This dedicated charger recharges the Ni-MH Pack NP-E2 quickly, taking about 100 minutes for one Pack. Excess recharging is also prevented. Two Packs can be attached at one time. It also has a discharge function (taking about 8.5 hours) which cancels the NP-E2 memory effect. It runs on 100 - 240 VAC.

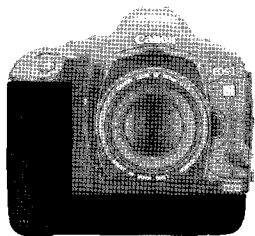

- **Battery Pack BP-E1**

The grip portion houses a 2CR5 lithium battery while the battery magazine holds four widely-available, size-AA alkaline batteries. You can switch between these two power sources to suit the shooting condition. The continuous shooting speed is the same as with the EOS-1V.

- **EOS LINK SOFTWARE ES-E1**

This enables the EOS-1V to be connected to a personal computer which can be used to further customize the EOS-1V.

The shooting data recorded by the EOS-1V can also be downloaded to the computer for viewing and editing. A dedicated cable is used to connect the EOS-1V's remote control/data transfer terminal to the personal computer's USB port. The software is compatible with personal computers with Windows 98 preinstalled.

* Windows is a registered trademark of Microsoft Corporation in the United States.



- **Camera Case EH-11L and EH-11LL**

Dedicated, semi-hard case which can accommodate the camera attached with a lens.

Accommodable lenses

EH-11L: EF 28-105mm f/3.5-4.5 USM

EH-11LL: EF 28-135mm f/3.5-5.6 IS

USM

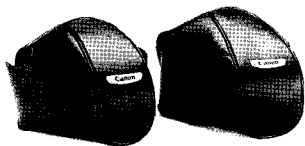



- **EX-series Speedlites 550EX, 380EX, and 220EX**

Three EOS-dedicated E-TTL autoflash Speedlites are available. The 550EX for a large flash output, the 380EX for affordable performance, and the 220EX for compactness. Their respective Guide numbers (at ISO 100 in meters) are 55, 38, and 22. All three Speedlites enable E-TTL autoflash, high-speed sync (FP flash), and FE lock. With the 550EX, an easy-to-use wireless, multi-Speedlite system is possible.



- **Macro Ring Lite MR-14EX**

EOS-dedicated macro ring flash featuring twin flash tubes, Guide No. 14 (at ISO 100 in meters), and E-TTL autoflash. You can fire only one or both flash tubes and control the flash ratio to easily obtain sophisticated lighting effects with E-TTL autoflash. Also, high-speed sync (FP flash), FE lock, and a wireless, multi-Speedlite (with 550EX as a slave) system are possible to achieve various macro flash effects.



- **Off-Camera Shoe Cord 2**

This cord enables the 550EX to be connected off-camera up to 60 cm away. All of the Speedlite's controls and features can be used as usual. The Cord can be used with all EX-series, EZ-series, and E-series Canon Speedlites.

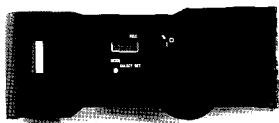

• **Date Back DB-E2**

This is an interchangeable camera back for the EOS-1V and EOS-3. It has a Quick Control Dial and date imprinting feature. The date can be imprinted on the photograph up to the year 2019.

The following imprinting modes are provided: 1. Year, month, day, 2. Day, hour, minute, 3. Blank, 4. Month, day, year, and 5. Day, month, year. It cannot imprint the film ID.



• **E-Series Dioptic Adjustment Lenses**

One of ten E-series dioptic adjustment lenses (-4 to +3 diopters) with eyecup can be attached to the camera's eyepiece to further expand the dioptic correction range.



• **Anti-Fog Eyepiece Ec**

This eyepiece does not fog up in cold temperatures. The eyepiece glass is coated with a special moisture-absorbing polymer which quickly absorbs moisture to dispel fogging of the glass.

The moisture absorbed evaporates naturally so the anti-fog effect is retained for a long time.



• **Timer Remote Controller TC-80N3**

Attached with an 80-cm cord, this remote switch has four built-in functions: 1. Self-timer, 2. Interval timer, 3. Long-exposure timer, and 4. Shutter release count setting. The time can be set anywhere from 1 sec. to 99 hours, 59 min., 59 sec. Its connection plug for the EOS-1V has a quick-lock feature.



- **Remote Switch RS-80N3**

Remote switch with an 80-cm cord to prevent camera shake for super telephoto shots, macrophotography, and bulb exposures. You can use the remote switch to press the shutter button halfway or completely. It also has a shutter release lock. Its quick-lock plug connects to the EOS-1V's remote control/data transfer terminal.



- **Extension Cord ET-1000N3**

Ten-meter extension cord for connecting the EOS-1V with Timer Remote Controller TC-80N3 or Remote Switch RS-80N3. For remote picture-taking situations.



- **Wireless Controller LC-4**

Wireless controller effective up to 100 meters. It comes with a transmitter and receiver. The receiver's camera connection plug connects to the EOS-1V's remote control/data transfer terminal with quick-lock feature.



- **Remote Switch Adapter RA-N3**

This plug adapter enables old Remote Switches (RS-60T3, etc.) having a threaded, 3-pin plug to be connected to the EOS-1V's new remote control terminal.

Major Specifications

• Type

Type	35mm AF/AE single-lens reflex with focal-plane shutter and built-in motor drive.
Picture size	24 mm x 36 mm
Compatible lenses	Canon EF lenses
Lens mount	Canon EF mount

• Viewfinder

Type	Eye-level pentaprism
Picture coverage	100 percent vertically and horizontally (20 mm eye relief)
Magnification	0.72x (-1 diopter with 50mm lens at infinity)
Built-in dioptic correction	-3 - +1 diopter. (Standard diopter: -1 dpt)
Focusing screen	Interchangeable (9 types), Standard focusing screen: Ec-CIII
Mirror	Quick-return half mirror (Transmission:reflection ratio of 37:63, no vignetting with EF 1200mm f/5.6 or shorter lens)
Viewfinder information	(1) On the screen: Area AF ellipse, focusing points, center spot metering circle (2) Below the screen: Manual exposure setting, AE lock, flash ready, unsuitable FE lock warning, high-speed sync (FP flash), shutter speed, FE lock (FEL), bulb (buLb), focusing point selection mode, depth-of-field AE (dep 1, 2), aperture, exposure compensation/flash exposure compensation amount, in-focus indicator. (3) Right of screen: Exposure level scale (\pm stops), exposure level indicator, flash exposure level, frame counter, frame count down indicator.
Depth-of-field Preview	Enabled with depth-of-field preview button
Eye-piece shutter	Built-in

• Exposure Control

Metering modes	TTL max. aperture metering with a 21-zone silicon photocell. (1) Evaluative metering (linkable to any focusing point) (2) Partial metering (approx. 8.5% of viewfinder at center) (3) Center spot metering (approx. 2.4% of viewfinder at center) (4) Focusing point-linked spot metering (approx. 2.4% of viewfinder) (5) Multi-spot metering (Max. 8 spot metering entries) (6) Centerweighted averaging metering
Exposure Control Methods	① Program AE (shiftable), ② Shutter speed-priority AE, ③ Aperture-priority AE, ④ Depth-of-field AE (not shiftable), ⑤ E-TTL program flash AE, ⑥ A-TTL program flash AE, ⑦ TTL

	program flash AE, ⑧ Manual, ⑨ Bulb (Safety shift possible for 2 and 3.)
Metering range	EV 0-20 for all metering modes (at 20°C with 50mm f/1.4 lens, ISO 100)
ISO film speed range.....	ISO 6-6400 (Set automatically with DX-coded film at ISO 25-5000.)
Exposure compensation.....	(1) Autoexposure bracketing (AEB): ± 3 stops in 1/3-stop increments. (2) Manual exposure compensation up to ± 3 stops in 1/3-stop increments set with the Quick Control Dial AEB and manual exposure compensation can be set together.
AE Lock	(1) Auto AE lock: Operates in One-Shot AF mode with evaluative metering when focus is achieved. (2) Manual AE lock: AE lock button activates AE lock in all metering modes.
Multiple exposures	Max. 9 multiple exposures per frame (Cancelable and resettable at any time.). Cancels automatically after all multiple exposures are taken.

• Autofocus

Type	TTL-AREA-SIR with a CMOS sensor
Focusing points	Area AF with 45 focusing points
AF working range	EV 0-18 (at ISO 100)
Focusing modes	(1) One-Shot AF: Autofocus stops when focus is achieved, resulting in AF lock. (2) AI Servo AF: Tracks subject movement up to the start of exposure. No in-focus indicator (blinks at 8 Hz only if AF fails). (3) Manual focusing: Enabled with the focusing ring when the lens focus mode is set to MF (or M). Electronic manual focusing during continuous shooting and exposure is enabled with PB-E2 and NP-E2.
In-focus indicator	Flashing focusing point in viewfinder (can be disabled with a Custom Function), in-focus indicator, and beeper (can be disabled with the Main Switch).
Focusing point selection.....	(1) Automatic selection: Focusing point camera-selected. (2) Manual selection: Focusing point manually-selected.
Focusing point registration and switching.....	Any single focusing point or 45-point automatic selection can be registered by pressing the Assist button and FE lock button simultaneously. Pressing the Assist button and focusing point selector switches to the registered focusing point.

Major Specifications

AF focusing point indicator	Superimposed focusing point in viewfinder and also indicated on LCD panel
AF-assist beam	Emitted automatically by the attached EOS Speedlite when necessary.

• Shutter

Type	Vertical-travel, focal-plane shutter with all speeds electronically-controlled.
Shutter speeds	30 to 1/8000 sec. in 1/3-stops, X-sync at 1/250 sec.
Shutter release	Soft-touch electromagnetic release
Self-timer	10-sec. or 2-sec. delay.

• Film Transport

Film loading	Automatic. After film is loaded and the back closed, the film advances to frame 1 automatically, taking about 1 sec.
Film advance system.....	Automatic film advance with built-in motor. (1) EOS-1 V: Single-frame and continuous shooting. (2) EOS-1 V HS (w/Power Drive Booster PB-E2): Single-frame, low-speed continuous, high-speed continuous, and ultra-high speed continuous (w/NP-E2).
Infrared film	Compatible
Film rewind system.....	At the end of the roll, automatic film rewind with a built-in motor. Midroll rewind possible.
Film rewind time/noise.....	High-speed rewind: Approx. 4.5 sec. for 24-ex. film and approx. 8 sec. for 36-ex. film at 59 dB
Silent rewind.....	Approx. 12 sec. for 24-ex. film and approx. 18 sec. for 36-ex. film at 49 dB

• Film ID Imprinting (w/standard camera back)

Information Imprinted	Any number from 00 to 99 and film No. from 001 to 999
Imprinting position and size	Frame 0 on film leader, text height approx. 1 mm
Imprinting method.....	After film advances during initial loading, a minilamp imprints a transparent LCD numerals on the film base. (Imprinting cannot be disabled.)
Imprinting confirmation.....	During imprinting, the ID mark lights on the LCD panel.
Ambient temperature.....	Imprinting assured between 45°C and -10°C
Power source	Same as for the camera

• Shooting Data

System	When a picture is taken, the shooting data is automatically recorded in the built-in memory. The data can be later transferred
--------------	--

- to a personal computer for viewing and editing.
- Data recorded See page 114. The data cannot be viewed or edited with the camera.
- Shooting data memory capacity With the standard number of data items, shooting data for 100 rolls of 36-ex. film can be stored.

• Camera Specifications

- Flash contacts (1) Hot shoe: X-sync direct contacts
(2) Right side bottom: PC terminal (threaded)
- External flash system compatibility E-TTL autoflash, A-TTL autoflash, TTL autoflash
- Custom Functions 20 (No. 0 - 19)
- Personal Functions 3 Custom Function groups can also be registered.
- Remote control Remote control/data transfer terminal with waterproof and dustproof cap provided.
- Power source (1) EOS-1 V: One 2CR5 lithium battery
(2) EOS-1 V HS (w/Power Drive Booster PB-E2): 8 size-AA batteries or Ni-MH Pack NP-E2 (sold separately)
(3) Battery Pack BP-E1: 1 2CR5 lithium battery and 4 size-AA batteries (size-AA lithium batteries cannot be used)
- Shooting capacity EOS-1 V: See page 20.
EOS-1 V HS: See page 117.
- Battery check Automatic when the Main Switch is turned on. Battery level displayed in four levels (not including blank display) on LCD panel.
- Dimensions EOS-1V: 161 (W) x 120.8 (H) x 70.8 (D) mm
6.3 (W) x 4.7 (H) x 2.8 (D) in.
EOS-1V HS: 161 (W) x 164.3 (H) x 82.5 (D) mm
6.3 (W) x 6.4 (H) x 3.2 (D) in.
- Weight EOS-1V: 945 g / 33 oz (body only, excluding battery)
EOS-1V HS: 1380 g / 48.7 oz (body only, excluding battery)

- All the specifications above are based on Canon's testing and measuring standards.
- Specifications and physical appearance are subject to change without notice.

Index

A	
Accessories	129
AEB	69
AE lock	71
AF Modes	34
- selecting	34
AI Servo AF	36
One-Shot AF	35
aperture-priority AE	58
aperture setting	120
with shutter speed display	126
<Av> aperture-priority AE	58
B	
basic operation	14
Basic Photography Terms	120
battery	
- installing	19
- level check	20
battery life	20, 117
bulb exposures	76
C	
continuous shooting	77
single-frame and continuous shooting switchover	77
Custom Functions	95
- setting	96
- canceling	97
- descriptions	98
- group registration	112
D	
default settings, reverting to	17
<DEP> depth-of-field AE	61
depth of field	121
depth-of-field AE	61
depth-of-field preview	80
dioptric adjustment knob	22
E	
E-TTL autoflash	85
electronic dials	15
eyecup	22
eyepiece shutter	80
exposure	120
- fixed	71
- set automatically	69
- exposure compensation	67
multiple exposures	74
exposure warnings	124
F	
FEB	90
FE lock	87
film	
- film ID imprinting	22
- loading	25
- unloading	28
- ISO speed	120
- ISO speed manual setting	73
- ISO speed checking	27
- midroll rewind	28
- film advance modes	117
flash photography	83
E-TTL flash photography	85
FEB	90
flash exposure compensation	89
Full Auto flash photography	85
non-Canon Speedlites, using	94
modeling flash	91
wireless, multi-Speedlite flash	92
focusing	
off-center subjects	45
manual focusing	48
Focusing point	
- selection procedure	38
- selecting	38
- registration	42
- activation area	44
Area AF ellipse and focusing points	37
registered focusing point switchover	43
automatic selection	38
manual selection	38
focusing screen interchanging	127
H	
high-speed sync (FP flash)	86
Holding the Camera	32

- I**
- infrared film, using 82
- L**
- LCD panel 10
 LCD panel illumination 82
 lens
 - mounting 21
 - detaching 21
- M**
- <M> manual exposure 65
 Main switch 14
 manual exposure 65
 manual focusing 48
 metering
 metering mode, selecting 50
 focusing point-linked spot metering 52
 spot metering 51
 centerweighted averaging metering 52
 evaluative metering 51
 partial metering 51
 multi-spot metering 53
 mirror lockup 81
 modeling flash 91
 multiple exposures 74
- N**
- Nomenclature 8
- P**
- <P> Program AE 29
 PC terminal 94
 performance specifications 134
 Personal Functions 111
 picture-taking
 AEB 69
 AE lock 71
 E-TTL autoflash 85
 FEB 90
 FE lock 87
 single-frame shooting 77
 flash photography 83
 infrared film, using 82
- self-timer 79
 Full Auto flash photography 85
 multiple exposures 74
 high-speed sync (FP flash) 86
 bulb exposures 76
 non-Canon Speedlites, using 94
 mirror lockup 81
 continuous shooting 77
 wireless, multi-Speedlite flash 92
 predictive AF 36
 Program AE 29
 program line 125
 program shift 31
- S**
- self-timer 79
 shooting data 115
 shutter button 14
 - half-way pressing 15
 - complete pressing 15
 shutter speed 120
 with aperture display 126
 shutter speed-priority AE 56
 single-frame shooting 77
 single-frame and continuous shooting,
 switching between 77
 strap, installing 13
- T**
- Troubleshooting Guide 122
 <Tv> shutter speed-priority AE 56
- V**
- viewfinder information 11
- W**
- wireless, multi-Speedlite flash 92
- X**
- X-sync speed 94

This device complies with Part 15 of the FCC Rules. Operation is subject to the following two conditions: (1) This device may not cause harmful interference, and (2) this device must accept any interference received, including interference that may cause undesired operation.

Do not make any changes or modifications to the equipment unless otherwise specified in the instructions. If such changes or modifications should be made, you could be required to stop operation of the equipment.

This equipment has been tested and found to comply with the limits for a class B digital device, pursuant to part 15 of the FCC Rules. These limits are designed to provide reasonable protection against harmful interference in a residential installation. This equipment generates, uses and can radiate radio frequency energy and, if not installed and used in accordance with the instructions, may cause harmful interference to radio communications.

However, there is no guarantee that interference will not occur in a particular installation. If this equipment does cause harmful interference to radio or television reception, which can be determined by turning the equipment off and on, the user is encouraged to try to correct the interference by one or more of the following measures:

- Reorient or relocate the receiving antenna.
- Increase the separation between the equipment and receiver.
- Consult the dealer or an experienced radio/TV technician for help.

This digital apparatus does not exceed the Class B limits for radio noise emissions from digital apparatus as set out in the interference-causing equipment standard entitled "Digital Apparatus", ICES-003 of the Industry Canada.



The CE Mark is a Directive conformity mark of the European Community (EC)

Canon

CANON INC. 30-2, Shimomaruko 3-chome, Ohta-ku, Tokyo 146-8501, Japan

U.S.A. ————— **CANON U.S.A., INC.**

For all inquiries concerning this camera, call toll free in the U.S. 1-800-652-2666 or write to: Customer Relations, Canon U.S.A., Inc.
One Canon Plaza, Lake Success, N.Y. 11042-1198

CANADA ————— **CANON CANADA INC. HEADQUARTERS**

6390 Dixie Road, Mississauga, Ontario L5T 1P7, Canada

CANON CANADA INC. MONTREAL BRANCH

5990, Côte-de-Liesse, Montréal Québec H4T 1V7, Canada

CANON CANADA INC. CALGARY OFFICE

2828, 16th Street, N.E. Calgary, Alberta T2E 7K7, Canada

For all inquiries concerning this camera, call toll free in Canada 1-800-652-2666

EUROPE, AFRICA & MIDDLE EAST ————— **CANON EUROPA N.V.**

Bovenkerkerweg 59-61, P.O. Box 2262, 1180 EG Amstelveen, The Netherlands

CANON PHOTO VIDEO FRANCE S.A.

11, Avenue Dubonnet Le Doublon 92407 Courbevoie Cedex, France

CANON UK LTD.

Woodhatch Reigate Surrey RH2 8BF United Kingdom

CANON EURO-PHOTO G.m.b.H

Siemensring 90-92, D-47877 Willich, Germany

CANON ITALIA S.p.A

Palazzo L, Strada 6, 20089 Rozzano, Milanofiori, Milano, Italy

CANON Benelux N.V./S.A.

Bessenveldstraat 7, 1831 Diegen (Machelen), Belgium

CANON Schweiz AG

Geschäftsbereich Wiederverkauf, Industriestrasse 12, CH-8305 Dietlikon, Switzerland

CANON G.m.b.H.

Oberlaaerstrasse 233, 4th floor, 1100 Wien, Austria

CENTRAL & SOUTH AMERICA ————— **CANON LATIN AMERICA, INC. DEPTO DE VENTAS**

6505 Blue Lagoon Drive, Suite 325, Miami, FL33126 U.S.A.

CANON LATIN AMERICA, INC. CENTRO DE SERVICIO Y REPARACION

Apartado 2019, Zona Libre de Colón, República de Panamá

ASIA ————— **CANON HONGKONG CO., LTD.**

9/F, The Hong Kong Club Building, 3A Chater Road, Central, Hong Kong

OCEANIA ————— **CANON AUSTRALIA PTY. LTD.**

1 Thomas Holt Drive, North Ryde, N.S.W. 2113, Australia

CANON NEW ZEALAND LTD.

Fred Thomas Drive, P.O. Box 33-336, Takapuna, Auckland, New Zealand

JAPAN ————— **CANON SALES CO., INC.**

12-15, Mita, 3-Chomé, Minato-ku, Tokyo 108-8011, Japan

This Instructions booklet is current as of February 2000. For information on using the camera with system accessories introduced after this date, contact your nearest Canon Service Center.